

TELEPHONE DIAGRAMS.

52

POSTAL ENGINEER'S BRANCH,
GENERAL POST OFFICE,
MELBOURNE.

772

AGGlatimer
Central Telephone
Exchange
Lonsdale St
Melbourne
1-1-26

4
5

TELEPHONE DIAGRAM BOOK - ERRATA.

Diagram No. 14 - Wall Set.

Present terminals are incorrectly numbered -

Terminal "No. 4" should be "No. 3"

Terminal "No. 3" should be "No. 1"

and the unnumbered terminal should be "Terminal No. 4"

Diagram No. 112.

Erase the word "Murray" as applied to the fourth diagram and substitute "Varley".



COMMONWEALTH OF AUSTRALIA.

POSTMASTER-GENERAL'S DEPARTMENT.



CONNECTIONS

OF

TELEPHONIC APPARATUS

AND

CIRCUITS

(Exclusive of Multiple Switchboard Circuits and Apparatus).



POSTMASTER-GENERAL'S DEPARTMENT,
MELBOURNE.

1914.

Price Three Shillings.

C 6133.—B

NOTE.

For purposes of economy the majority of the diagrams included in this book have been copied from existing drawings prepared and used in the different States prior to the adoption of standard conventions. It has not, therefore, been possible to adhere throughout to the conventional signs for diagrams shown on Diagram No. 103.

List of Telephones, Switches, and Switchboards.

WALL TELEPHONES.

PRESENT TITLE.	PREVIOUS TITLE.
Telephone—	
No. 1. Telephone, Magneto, Wall,	Commonwealth Type.
" 3.	Ericsson, Type A.
" 5.	Bridging Type (B.I.H. Co.).
" 7.	Bridging Type; (Hunning's Cone).
" 9.	Bridging Type (Delville).
" 11.	" (W. E. Delville).
" 13.	Non-bridging Type (Hunning's Cone.)
" 15.	Common Battery, Wall (W.E. Type).
" 17.	" (B.I. Type).
" 19.	" (G.E. Type).
" 21.	" (Ericsson Type).
" 23.	Party Line (Ericsson Type).
" 25.	Common Battery, Wall, Two Party Line.
" 27.	" " " Main Set and Extension Switch (W.E. Type).
" 29.	Common Battery, Wall, Extension Set, with Generator (W.E. Type).
" 31.	Automatic, Wall (Geelong).
" 33.	" " with Control Lock (Automatic Electric Coy. Type).
" 35.	Automatic, Wall, Party Line (Geelong).
" 37.	Condenser (Ericsson Type).
" 39.	" Buzzer.
" 41.	Closed Circuit Buzzer.
" 43.	Open Circuit Buzzer.
" 45.	Phonopore.

NOTE.—Odd numbers have been allotted to Wall Telephones and Even numbers to Table Telephones.

TABLE TELEPHONES.

PRESENT TITLE.

PREVIOUS TITLE.

Telephone—

No. 2.	Telephone, Magneto, Table, Commonwealth Type.
" 4.	" " " Bridging Type (Ericsson).
" 6.	" " Common Battery, Table, Series with Electro-magnetic Receiver (G.E. Type).
" 8.	" " Common Battery, Table, (Ericsson Type).
" 10.	" " " " " " " "
" 12.	" " " " " (B.I. Type). "
" 14.	" " " " " (W.E. Type).

NOTE.—Odd numbers have been allotted to Wall Telephones and Even numbers to Table Telephones.

SWITCHES.

PRESENT TITLE.

PREVIOUS TITLE.

Switch—

No. 1.	Switch, Magneto, Intermediate (Ericsson Type).
" 2.	" " " " (Capstan Type).
" 3.	" " Common Battery, Single Extension and Inter-communication, with Visual Signal (Commonwealth Type).
" 4.	" " Common Battery, Intermediate (B.I. Type).
" 5.	" " " " " (B.I. T823 Type).
" 6.	" " Common Battery, Single Extension and Inter-communication, with Visual Signal (Ericsson Type).
" 7.	" " Common Battery, Intermediate, with Press Buttons (W.E. Type).

CORDLESS SWITCHBOARDS.

PRESENT TITLE.

PREVIOUS TITLE.

Switchboard—

No. 1.	Switchboard,	Cordless,	Magneto,	P.B. Exchge.,	four lines (Ericsson Type).
„ 3.	„	„	„	„	Magneto, P.B. Exchge., ten lines (W.E. Type).
„ 5.	„	„	„	„	Common Battery, P.B. Exchge. (Ericsson Type).
„ 7.	„	„	„	„	Common Battery, P.B. Exchge., four lines (W.E. Type).
„ 9.	„	„	„	„	Common Battery, P.B. Exchge., four lines (B.I. Type).

CORD SWITCHBOARDS.

PRESENT TITLE.

PREVIOUS TITLE.

Switchboard—

No. 2.	Switchboard,	Cord,	Magneto,	P.B. Exchge. (B.I. Type).	
„ 4.	„	„	„	„	„ (Ericsson Type).
„ 6.	„	„	„	„	„ (W.E. Type).
„ 8.	„	„	„	„	„ 50 or 100 lines (W.E. Floor Pattern).
„ 10.	„	„	„	„	Non-multiple, B Position.
„ 12.	„	„	„	„	Common Battery, P.B. Exchge. (Commonwealth Type).
„ 14.	„	„	„	„	Battery, P.B. Exchge. (B.I. Type).
„ 16.	„	„	„	„	„ P.B. Exchge. (Ericsson Type).
„ 18.	„	„	„	„	„ P.B. Exchge., with Eyeball Indicator (W.E. Type).
„ 20.	„	„	„	„	Common Battery P.B. Exchge., with Drop Indicator (W.E. Type).

NOTE.—Odd numbers have been allotted to Cordless Switchboards and Even numbers to Switchboards of the Cord type.

CONTENTS.

PART I.—TELEPHONES.

SECTION 1.—WALL TELEPHONES—MAGNETO, COMMON BATTERY, AND AUTOMATIC.

TITLE.	Cw'lth. or State Drawing No.	Diagram No.
Telephone, Wall Type—		
No. 1. Wiring Diagram	V. 2462	.. 1
„ 1. Fitted with Condenser for C.B. Service	V. 681	.. 2
„ 1. Circuits of	C. 42 3
„ 3. Wiring Diagram	V. 2454	.. 4
„ 3. Fitted with Condenser for C.B. Service, without Extension Bell	V. 683	.. 5
„ 3. Fitted with Condenser for C.B. Service with Extension Bell..	V. 684	.. 6
„ 3. Schematic Circuits of	V. 2455	.. 7
„ 3. „ „	V. 2456	.. 8
„ 5. Circuits of	N.S.W. EQ2	.. 9
„ 7. „ „	N.S.W. EQ35	.. 10
„ 9. Circuits of (Fitted for use as Public Telephone)	N.S.W. EQ112..	.. 11
„ 11. Circuits of	N.S.W. EQ79	.. 12
„ 13. „ „	N.S.W. EQ134..	.. 13
„ 15. Wiring Diagram	V. 2442	.. 14
„ 17. Wiring Diagram and Schematic Circuits of	V. 2457	.. 15
„ 19. Circuits of	V. 854	.. 16
„ 21. Wiring Diagram and Schematic Circuits of	V. 2452	.. 17
„ 23. Circuits of	Q. 1506	.. 18
„ 25. Wiring Diagram and Schematic Circuits of	V. 2466	.. 19
„ 27. Circuits of	V. 2458	.. 20
„ 29. „ „		
„ 31. „ „	V. 3067	.. 21
„ 33. Wiring Diagram and Schematic Circuits of	C.A. 192	.. 22
„ 35. Circuits of	V. 3068	.. 23

NOTE.—See List of Telephones for Previous Titles of Telephones.

SECTION 2.—TABLE TELEPHONES—MAGNETO, COMMON BATTERY, AND AUTOMATIC.

TITLE.	C'with. or State Drawing No.	Diagram No.
Telephone, Table Type—		
No. 2. Wiring Diagram	V. 2585	.. 24
„ 2. Fitted with Condenser for C.B. Service	V. 682	.. 25
„ 2. Schematic Circuits of	C. 41	.. 26
„ 4. Wiring Diagram	V. 685	.. 27
„ 4. Fitted with Condenser, for C.B. Service, without Extension Bell	V. 2593	.. 28
„ 4. Fitted with Condenser, for C.B. Service, with Extension Bell	V 686	.. 29
„ 6. Wiring Diagram and Schematic Circuits of	V. 2453	.. 30
„ 8. Wiring Diagram	Q. 1496	.. 31
„ 10. Circuits of	N.S.W. EQ1	.. 32
„ 12. Wiring Diagram and Schematic Circuits of	V. 2457	.. 15
„ 14. Wiring Diagram	V. 2442	.. 14

NOTE.—See List of Telephones for Previous Titles of Telephones.

SECTION 3.—TELEPHONES FOR SUPERIMPOSED CIRCUITS.

TITLE.	C'with. or State Drawing No.	Diagram No.
Telephone, Wall Type—		
No. 37. Circuits of	N.S.W. EQ15	.. 33
„ 39. „	V. 440	.. 34
„ 41. „	V. 629	.. 35
„ 43. „	V. 2473 A	.. 36
„ 45. „	Q. 1584 A	.. 37
Telephone, Portable, Medhurst, Circuits of 38

NOTE.—See List of Telephones for Previous Titles of Telephones.

PART II.—SWITCHES AND SWITCHBOARDS.

SECTION 1.—SWITCHES—MAGNETO AND COMMON BATTERY.

TITLE.	C'with. or State Drawing No.	Diagram No.
Switch, Telephone Type—		
No. 1. Wiring Diagram	V. 2518	.. 39
„ 1. Schematic Diagram showing three positions of	N.S.W. EQ144..	40
„ 2. Fitted with Condenser for C.B. Service, Wiring Diagram	V. 689	.. 41
„ 2. Diagram showing .. three positions of	N.S.W. EQ25	.. 42
„ 3. Schematic Circuits of	C. 216	.. 43
„ 4. Wiring Diagram	V. 2469	.. 44
„ 4. Schematic Circuits of	V. 2533	.. 45
„ 5. Circuits of	V. 2350	.. 46
„ 6. „	N.S.W. EQ31	.. 47
„ 7. Wiring Diagram and Circuits of	V. 2357	.. 48

NOTE.—See List of Switches for Previous Titles of Switches.

SECTION 2.—SWITCHBOARDS, CORDLESS—MAGNETO AND COMMON BATTERY.

TITLE.	C'with. or State Drawing No.	Diagram No.
Switchboard, Cordless Type—		
No. 1. Circuits of	N.S.W. EQ123..	49
„ 3. Wiring Diagram	V. 1612	.. 50
„ 5. Circuits of	S.A. 358	.. 51
„ 7. „	V. 975	.. 52
„ 9. „	V. 2345	.. 53

NOTE.—See List of Switchboards for Previous Titles of Switchboards.

SECTION 3.—SWITCHBOARDS, CORD—MAGNETO AND
COMMON BATTERY.

TITLE.	C'wth. or State Drawing No.	Diagram No.
Switchboard, Cord Type—		
No. 2. Circuits of	N.S.W. EQ245 ..	54
„ 4. „	N.S.W. EQ19 ..	55
„ 6. „	N.S.W. EQ246 ..	56
„ 8. „	V. 2461 ..	57
„ 10. „	V. 2463 ..	58
„ 12. „	C. 203 ..	59
„ 14. Wiring Diagram	V. 2521 ..	60
„ 16. Circuits of	N.S.W. EQ359 ..	61
„ 18. „	V. 2459 ..	62
„ 20. „	V. 953 ..	63

NOTE.—See List of Switchboards for Previous Titles of Switchboards.

PART III.—TRUNK LINES.

SECTION 1.—MAGNETO TRUNK LINE CIRCUITS.

	C'wth. or State Drawing No.	Diagram No.
Magneto Trunk Line Systems	V. 1219 ..	64
Intermediate Trunk Line Station Connections	Q. D265 ..	65
Trunk Line Circuits, various	66
Trunk Line, with Morse Superimposed, Terminal Station Connections	V. 1129 ..	67

SECTION 2.—CONDENSER TRUNK LINE CIRCUITS.

	C'wth. or State Drawing No.	Diagram No.
Circuits of Sydney-Melbourne Trunk Line (at Melbourne)	V. 998	.. 68
Condenser Trunk Line Systems	V. 1218	.. 69
Condenser Telephone Station, Single Line, Intermediate, without Morse Set	S.A. 477	.. 70
Condenser Telephone Station, Single Line, Intermediate	V. 618	.. 71
Condenser Telephone Station, Single Line, Intermediate	V. 619	.. 72
Condenser Telephone Station, Single Line, Intermediate—equipped for dividing the Telephone Circuit	V. 620	.. 73
Condenser Telephone Station, Metallic Line, Intermediate	V. 621	.. 74
Condenser Telephone Station, Metallic Line, Terminal	V. 622	.. 75
Condenser Telephone Station, Metallic Line, terminated on Switchboard for Night Ser- vice	V. 1004	.. 76

PART IV.—MISCELLANEOUS.

SECTION 1.—TELEPHONE CIRCUITS.

	C'wth. or State Drawing No.	Diagram No.
Telephones, Magneto, working on C.B. System, Improved Connections for ..	C.A. 179	.. 77
Telephone C.B. Main and Auxiliary, to receive Calls on Auxiliary Set—no intercommunication	V. 2392	.. 78
Telephone C.B. Main and Auxiliary, using one Coil and Condenser—no intercommunication	V. 2393	.. 79
Telephones, C.B., with Control Keys ..	V. 1689	.. 80
Telephones, C.B., Tapper, with Keys ..	V. 2362	.. 81
Telephone Stations, C.B. Main and Extension, Method of Wiring	V. 1686	.. 82
Telephone, C.B., Method of connecting Ericsson Party Line Register to ..	S.A. 153 (amended)	.. 83
Intercommunicating System, C.B., W.E., No. 2	V. 2434	.. 84
Intercommunicating System, C.B., W.E., No. 2	V. 2435	.. 85
Intercommunicating System, C.B., W.E., No. 2—Telephone Circuits (Schematic) ..	V. 2436	.. 86
.....		
.....		
.....		
.....		
.....		
.....		

SECTION 2.—SWITCHBOARD CIRCUITS.

	C'wth. or State Drawing No.	Diagram No.
Switchboard, Magneto, P.B. Exchange, fitted with Condensers for C.B. Service ..	V. 687A	.. 87
Switchboard, Magneto, P.B. Exchange, fitted with Holding Coil for C.B. Service ..	V. 1750	.. 88
Switchboards, Magneto, Earthed Circuit, Transfer Circuit (one way), for ..	V. 1986	.. 89

SECTION 2.—SWITCHBOARD CIRCUITS—(continued).

	C'wlth. or State Drawing No.	Diagram No.
Switchboards, Magneto, Metallic Circuit, Transfer Circuit (one way), for ..	V. 1617	.. 90
Switchboard, C.B., Cordless, P.B. Exchange, adapted for Working on Automatic Systems	V. 3089	.. 91
Switchboard, C.B. (W.E. No. 1), Subscriber's Line Circuit	V. 1221	.. 92
Switchboard, C.B. (B.I. Coy.), Subscriber's Line Circuit	W.A. 287	.. 93
Switchboard, C.B. (G.E. Coy.); Subscriber's Line Circuit	V. 1094	.. 94
.....		
.....		
.....		
.....		
.....		
.....		

SECTION 3.—APPARATUS (VARIOUS).

	C'wlth. or State Drawing No.	Diagram No.
Busy Back, Battery Operated, Wiring Dia- gram and Schematic Circuits of ..	V. 2472	.. 95
Polechanger (W.E. No. 62—A), Wiring Dia- gram and Schematic Circuits of ..	V. 1177	.. 96
Polechanger, Battery (old form), Circuits of	V. 2588	.. 97
Polechanger, Sandwich Type, Circuits of ..	V. 2589	.. 98
Polechanger, Battery, Warner Type, Circuits of	Q. D241	.. 99
Polechanger, Noyes' Vibratory Transformer, Schematic Circuits of	V. 2587	.. 100
Protectors, M.D.F. (W.E. Type), Wiring Diagram 101
Cells, Dry, Method of Connecting..	V. 1511	.. 102
.....		
.....		
.....		
.....		
.....		
.....		

SECTION 4.—CONVENTIONAL SIGNS, ETC.

	C'wth. or State Drawing No.	Diagram No.
Signs, Conventional, to be used on Diagrams	V. 2470	.. 103
Keys, Union, Types of 104
Voice Value, Telephone, Standard	.. V. 1035	.. 105

PART V.—TESTING APPARATUS AND ELECTRICAL MEASUREMENTS.

	C'wth. or State Drawing No.	Diagram No.
Transmission Circuit, Standard C.A. 163	.. 106
Line, Artificial, for Transmission Tests	.. Q. 1711	.. 107
Line, Artificial, for Transmission Tests on C.B. Telephones prior to Installation (E.C. 95) S.A. 367	.. 108
Measurement of Conductor Resistance by means of Wheatstone Bridge (P.O. Box) 109
Measurement of Resistance by means of Milliamperemeter Testing Set V. 2363	.. 110
Measurement of Resistance by means of Volt- meter and Ammeter V. 2467	.. 111
Measurement of Resistance by means of Bridge Megger V. 2360	.. 112
Measurement of Insulation Resistance by means of Reflecting Galvanometer 113
Measurement of Capacity by the Direct Deflection Method 114
Measurement of Capacity by Thomson's Method 115
Loop Test, Murray's, Connexions for V. 2353	.. 116
Loop Test, Varley's, Connexions for V. 2358	.. 117
Lineman's Detector (B.P.O. Type), Circuits of V. 1633	.. 118
Insulation Test of Translator by means of Commonwealth Magneto Telephone V. 616	.. 119
Testing Set, Magneto Exchange, Ericsson V. 2478	.. 120

APPENDIX.

Voltage and Internal Resistance of Primary Cells ..	I.
Cells connected in Series and in Parallel-Series ..	II.
Condensers connected in Series and in Parallel ..	III.
Joint Resistance of Conductors connected in Parallel ..	IV.
Ohm's Law	V.
Measurement of Internal Resistance of Battery by Half Deflection Method	VI.
Resistance of various Conductors in General Use ..	VII.
Table of Fusing Currents for Wires	VIII.
Table of Co-efficients for converting Observed Copper Resistance .. \	IX.
Numbers of Wires in Small Flexible Conductors ..	X.
British Standard Wire Gauge	XI.
Useful Numbers	XII.
Conversion Tables	XIII.
Colour Code for Switchboard Cables	XIV.
Table of Equivalent Lengths of Line and Limiting Distances for Commercial Speech	XV.
Curves showing Transmission Values of various Aerial and Underground Conductors in Terms of Standard Cable	XVI.
Table of the Effective Resistance, Inductance, and Impedance of Standard Telephone Apparatus ..	XVII.

Part I.—Telephones.

SECTION 1.

Wall Telephones—Magneto, Common
Battery, and Automatic.

COMMON WEALTH
M.W.I

(7)

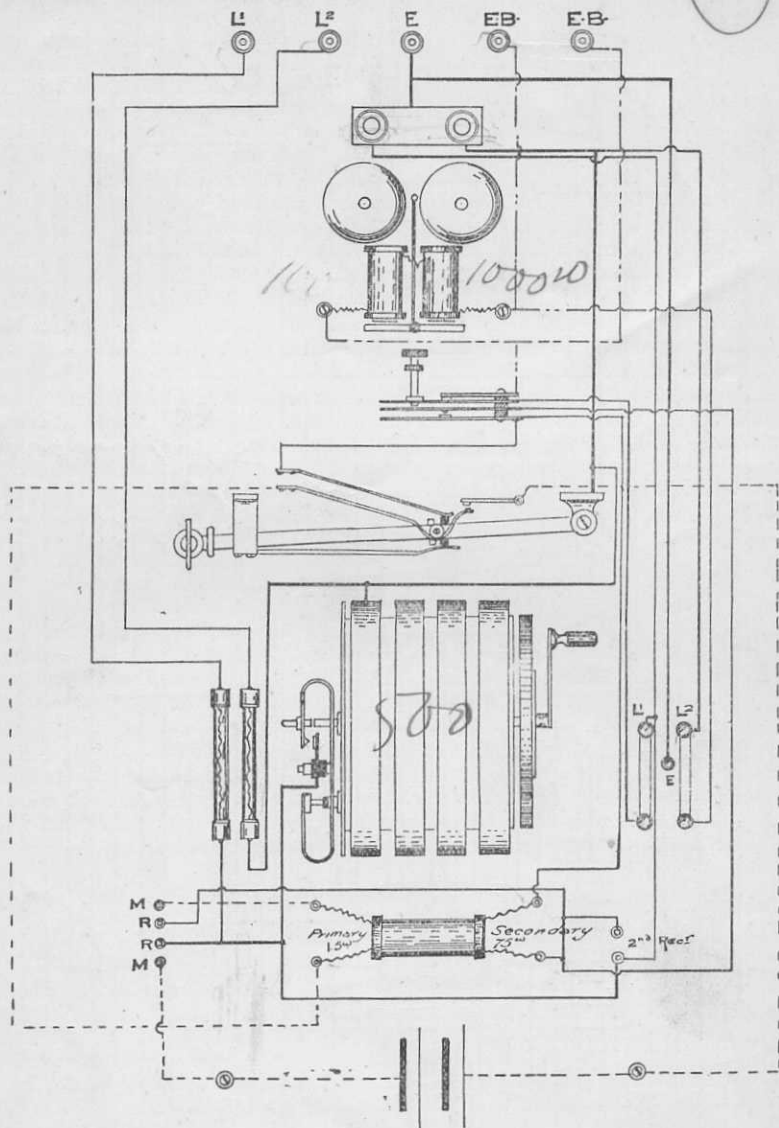

Rec 120
Trans 60

Diagram 1.

COMMONWEALTH M.W.1
 FITTED WITH CONDENSER FOR
 C.B. SERVICE

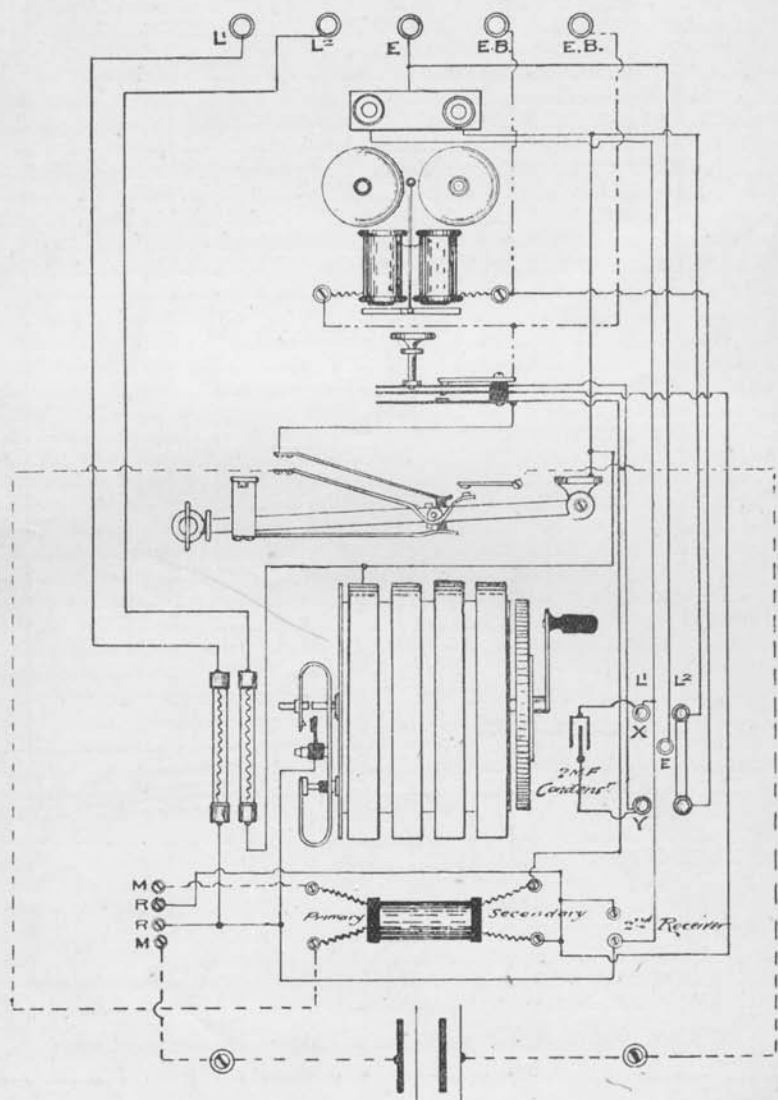
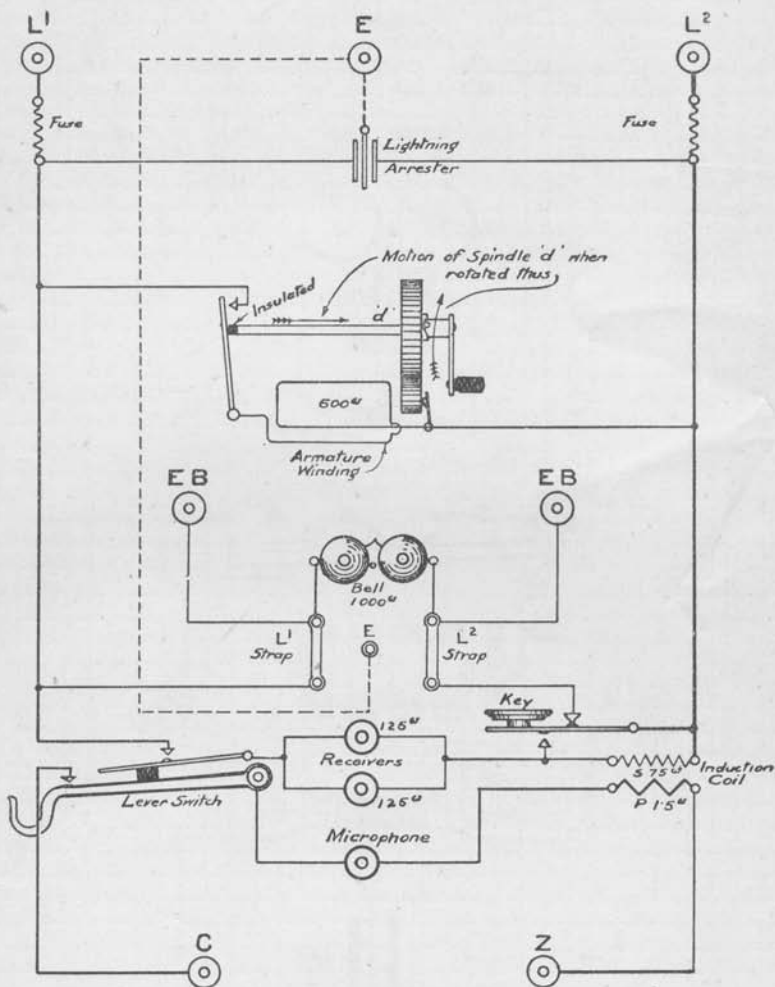

Diagram 2.

COMMONWEALTH M.W.I
SCHEMATIC



When Generator is idle circuit from L^1 to L^2 through Armature Winding is open.

ERICSSON M.W.1
TYPE A

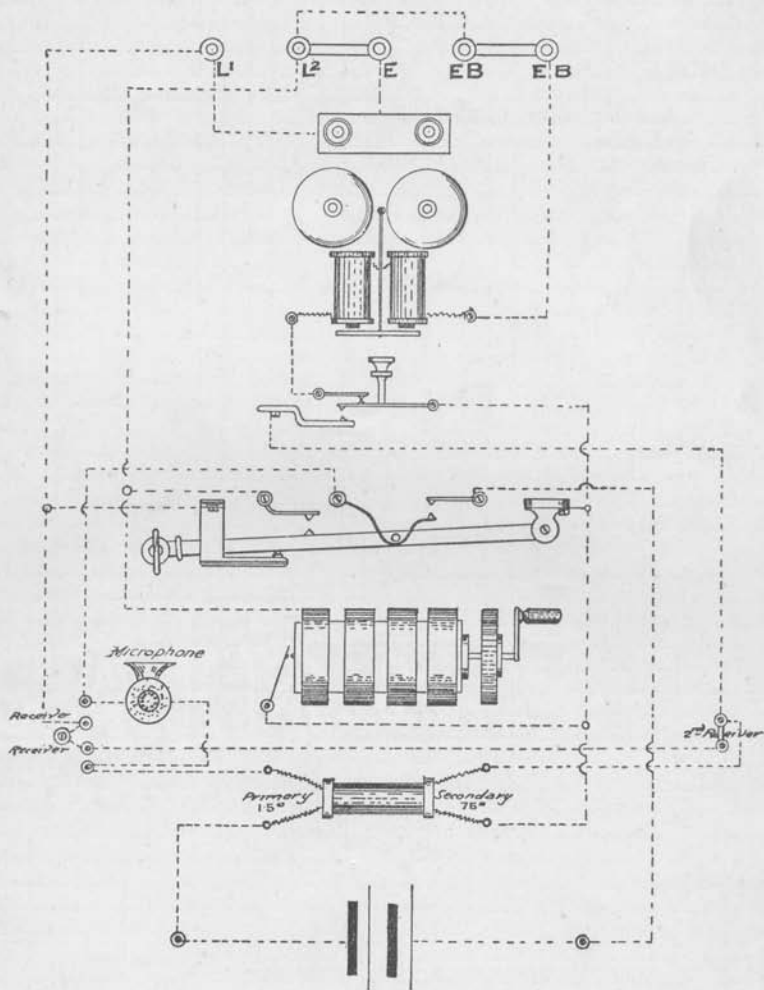

Diagram 4.

ERICSSON M.W.1

FITTED WITH CONDENSER
FOR C.B. SERVICE WITHOUT EXTENSION BELL

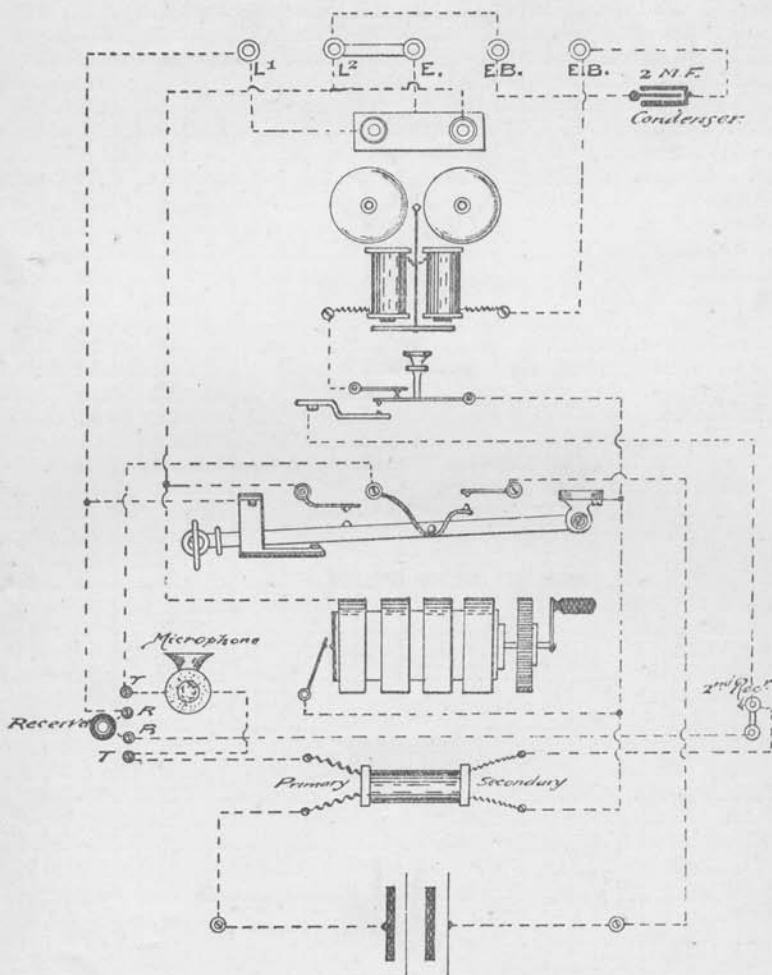

Diagram 5.

ERICSSON M.W.1
 FITTED WITH CONDENSER FOR
 C-B SERVICE WITH EXTENSION BELL

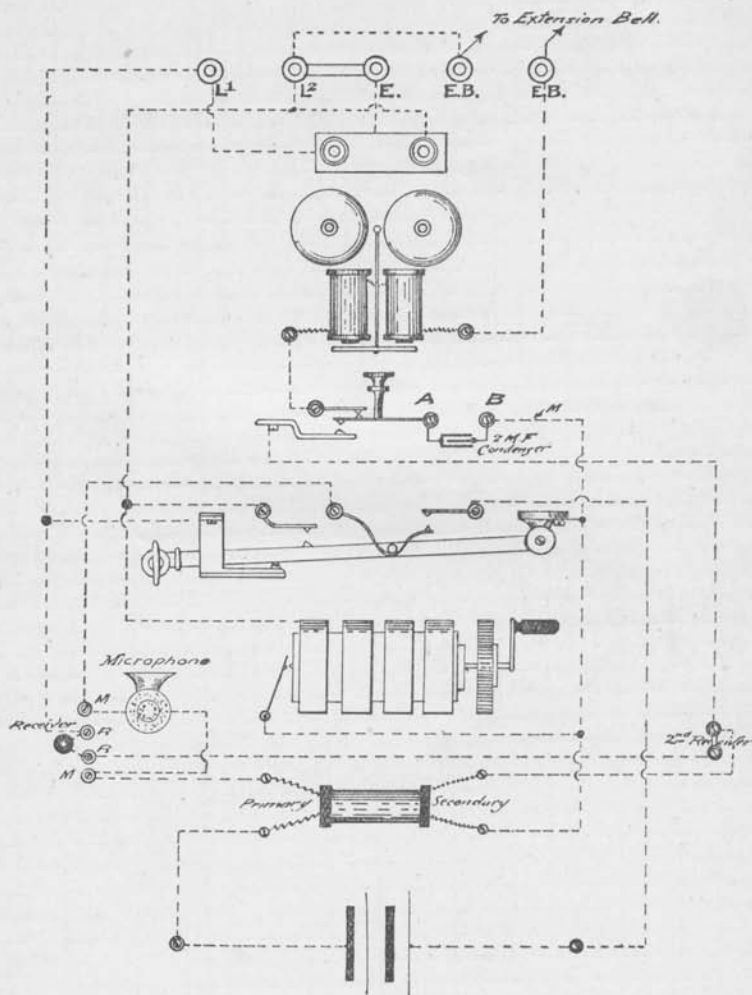
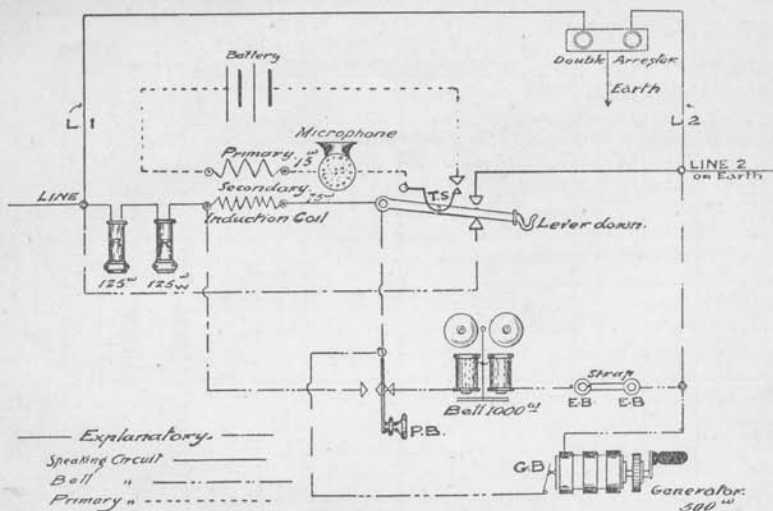

Diagram 6.

Theory of connections "Bell on."



Theory of connections "Speaking"

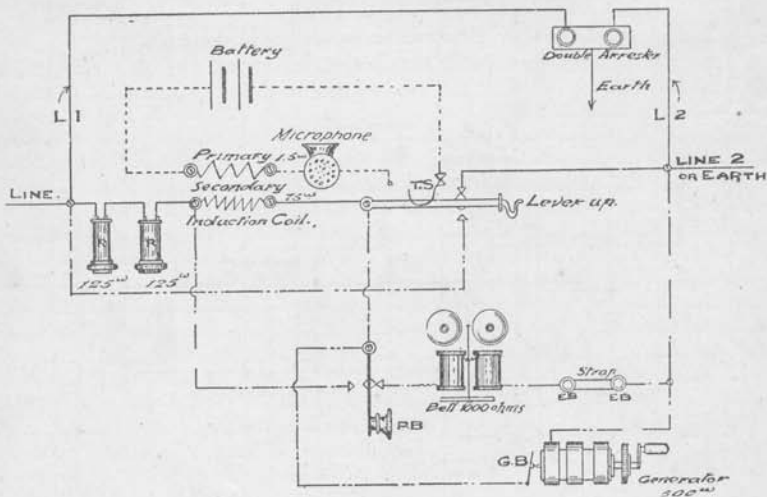
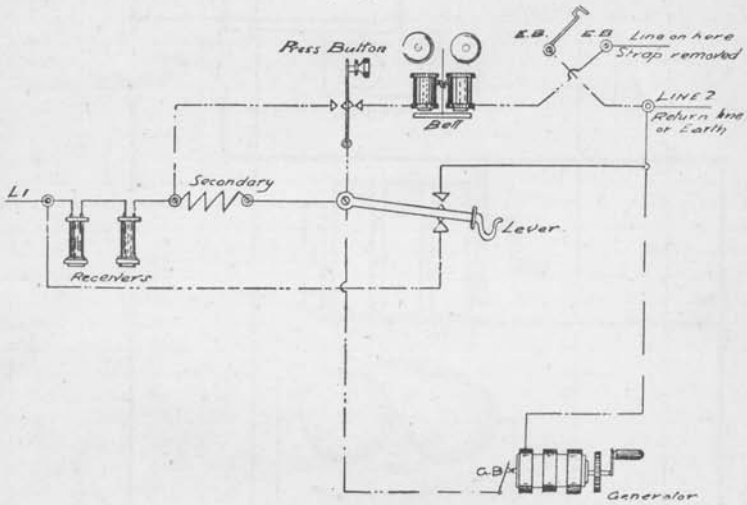
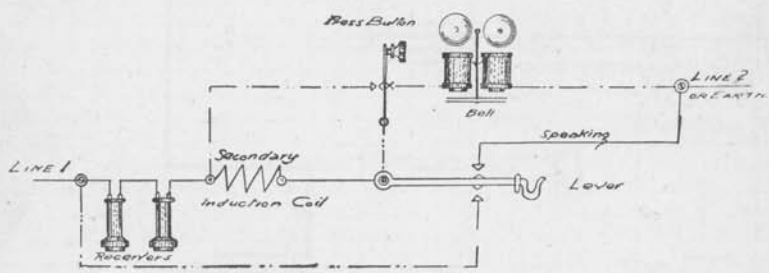

Diagram 7.

Connections for ringing, test of line



Simple diagram of circuit's Microphone
circuit omitted.



————— Exploratory —————
 - - - - - Speaking Circuit - - - - -
 Bell

Diagram 8.

BRIDGING TYPE
B.I.H & CO.

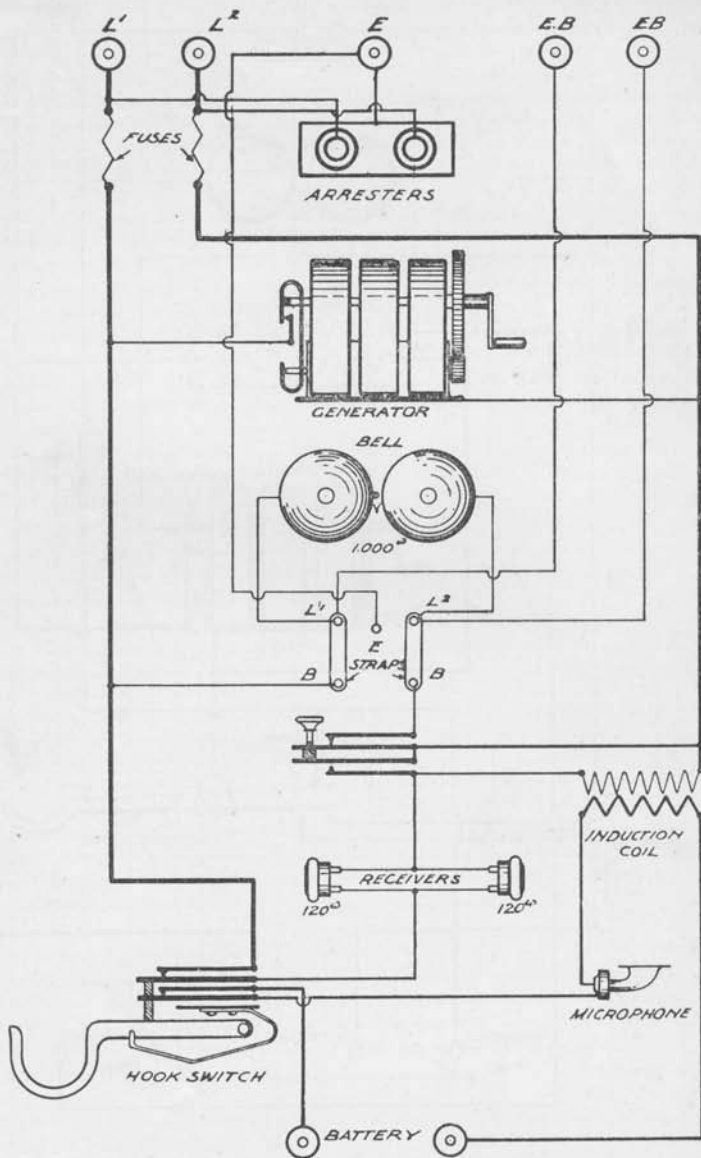

Diagram 9.

HUNNINGS.
BRIDGING TYPE

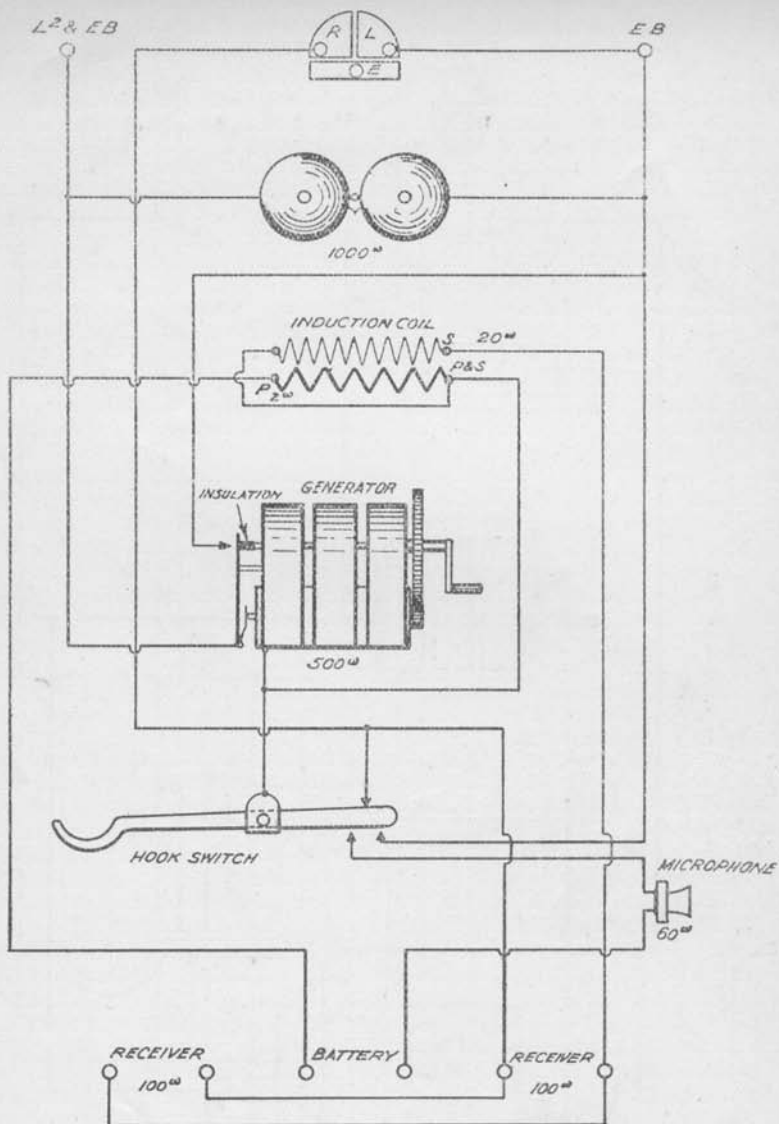

Diagram 10.

BRIDGING TYPE
FITTED FOR P.T.

32

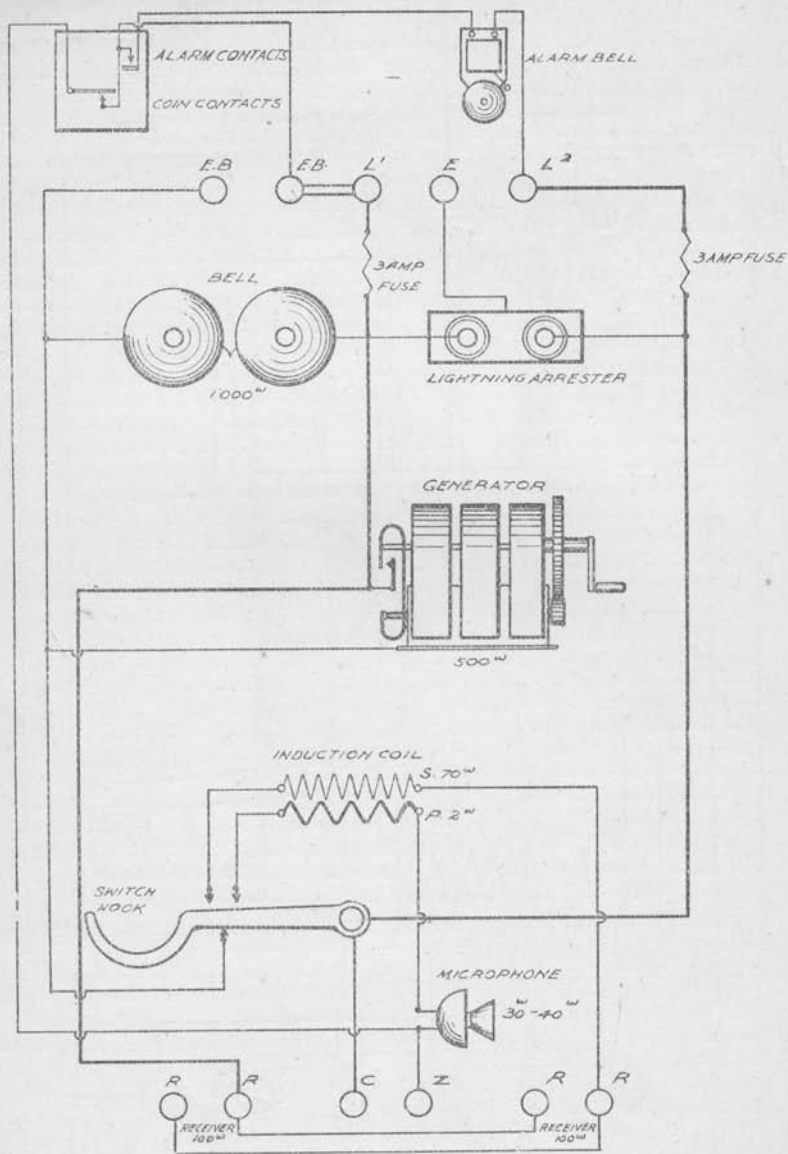

Diagram 11.

M.W.
N.E

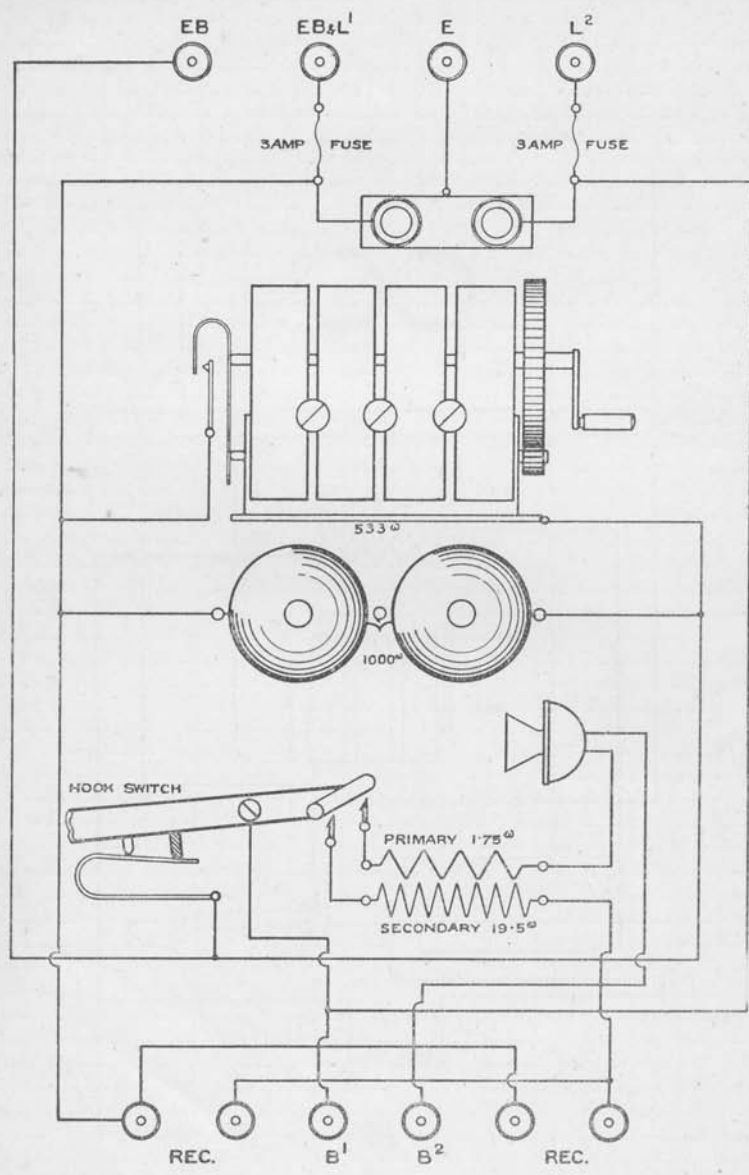

Diagram 12.

HUNNING'S
NON BRIDGING

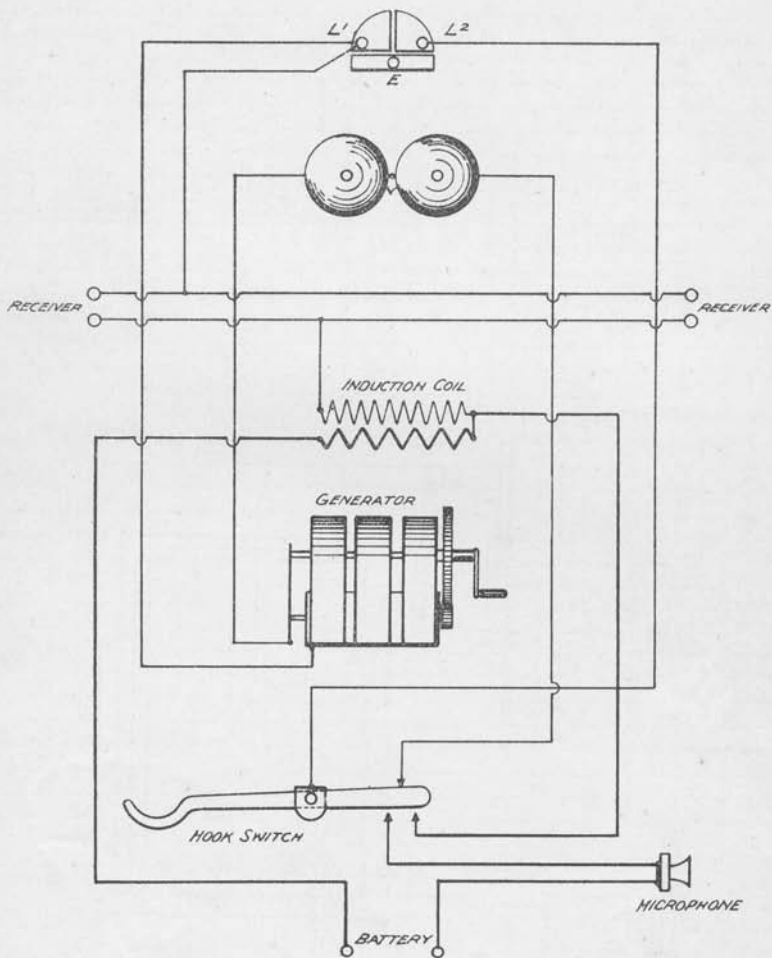
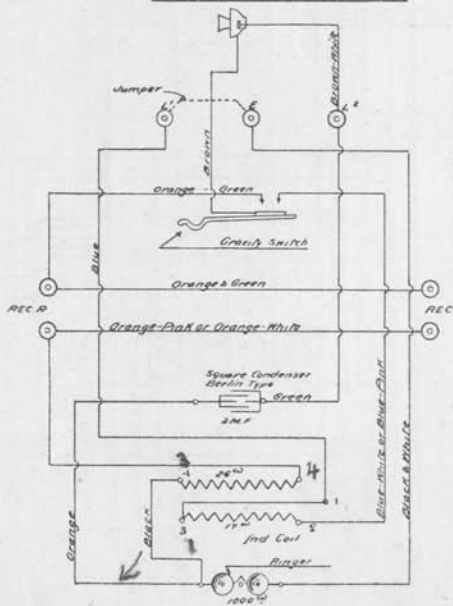

Diagram 13.

COMMON BATTERY
W. E.

WALL SET (2392A)



SEE
NOTE IN FRONT

N.B. When Extension Bell installed, remove Jumper and connect between L and E

TABLE SET

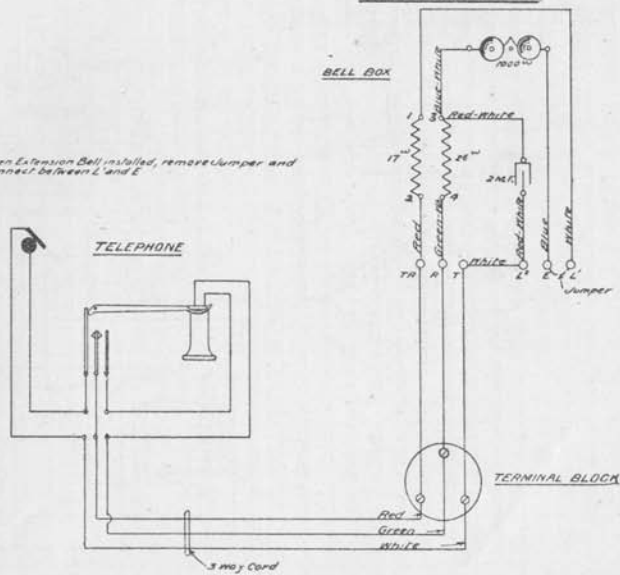

COMMON BATTERY B-1

— WALL SET —

— TABLE SET —

— WIRING DIAGRAMS —

— THEORY OF CONNECTIONS —

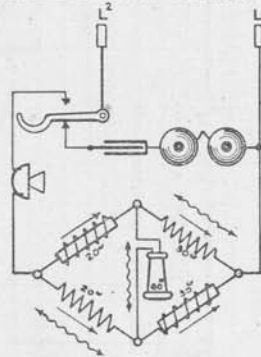
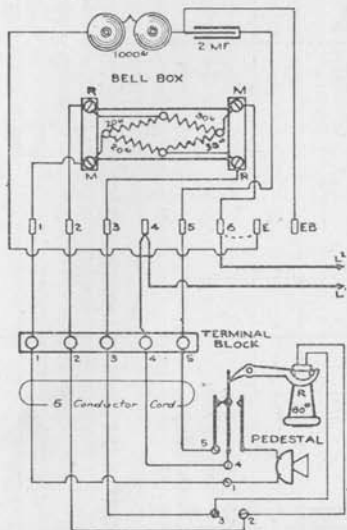
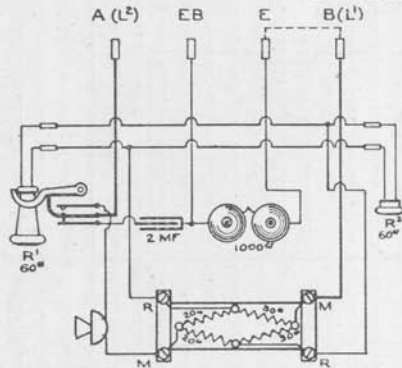

NB When Extension Bell is installed, remove Jumper and connect between E & B. The EB Terminal must not be used.

COMMON BATTERY
Q.E. TYPE

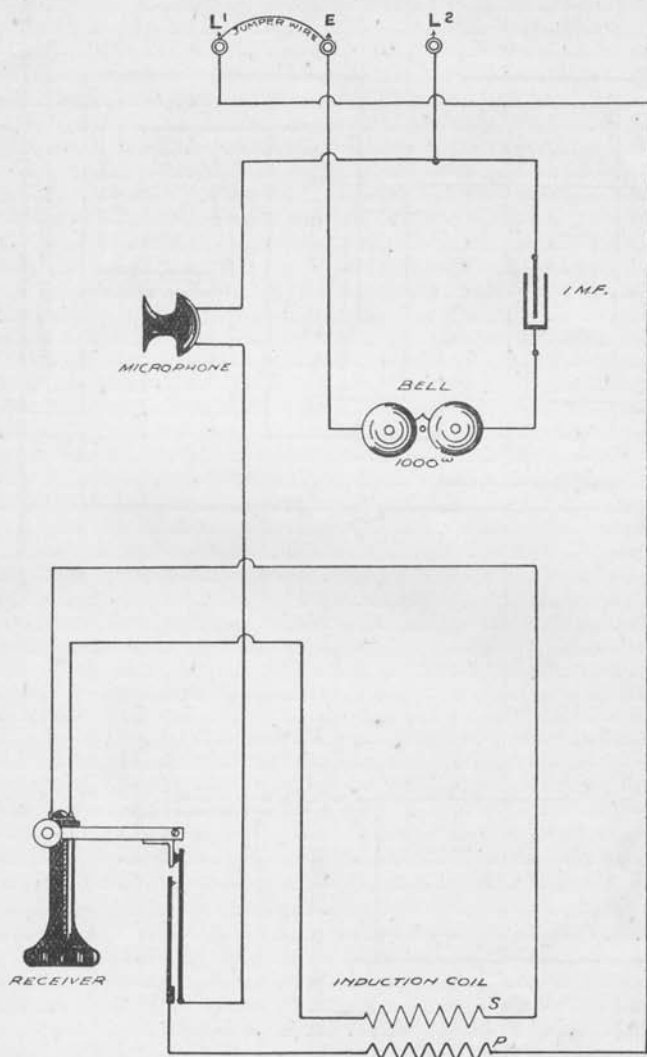

NOTE: WHEN EXTENSION BELL IS INSTALLED, REMOVE JUMPER AND CONNECT BETWEEN L¹ AND E.

Diagram 16.

COMMON BATTERY ERISSON, TYPE

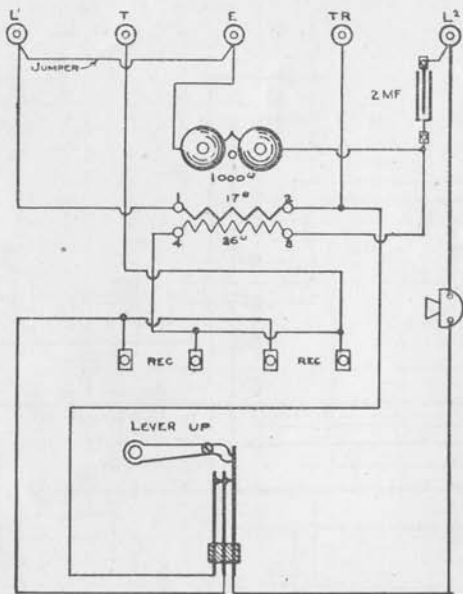

WIRING DIAGRAM

When Extension Bell is installed, remove jumper and connect between L1 & E

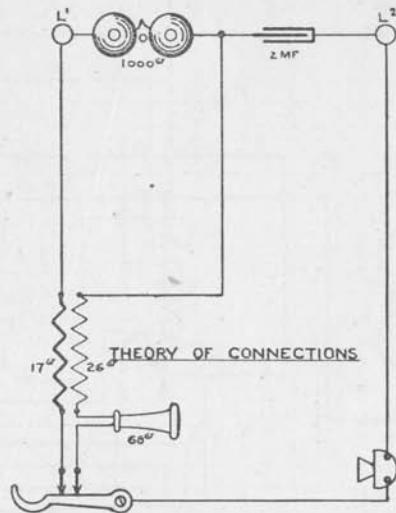

NB This arrangement is exactly similar to WE Coy's Instruments.

Diagram 17.

COMMON BATTERY
ERICSSON PARTY
LINE

28

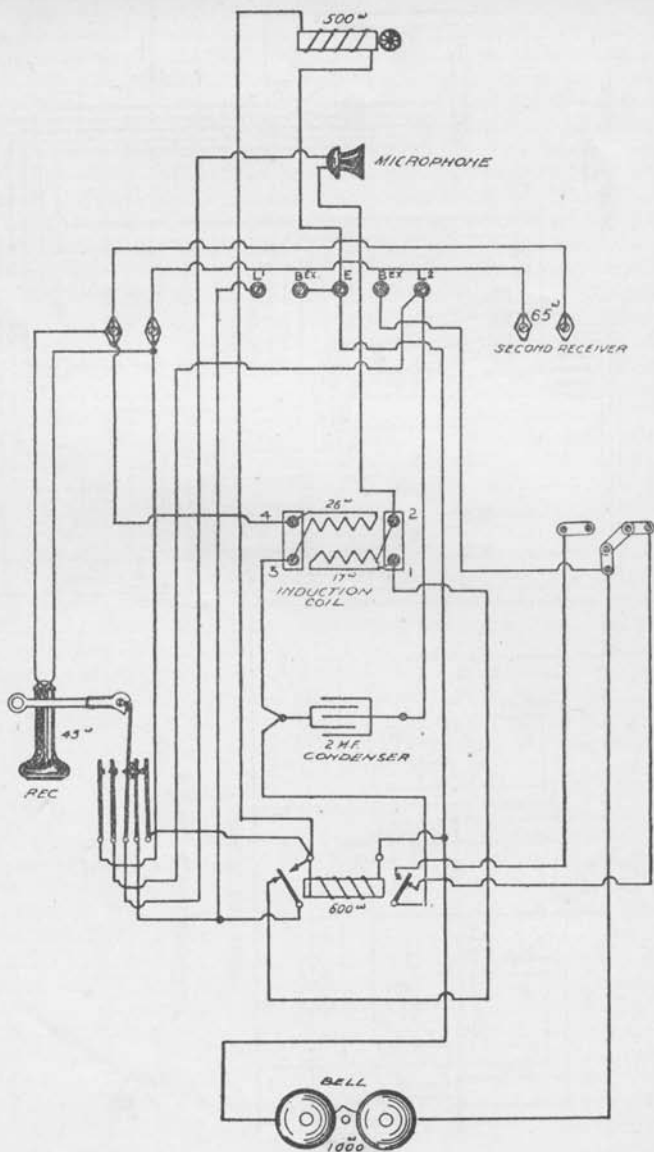
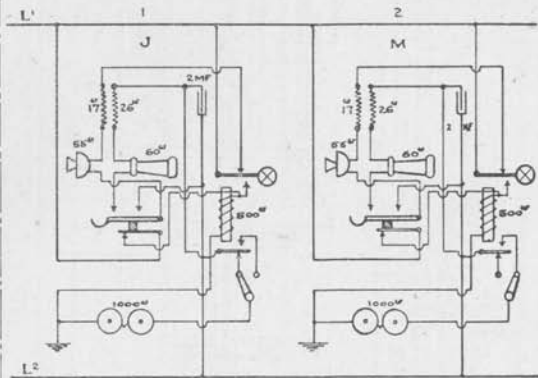
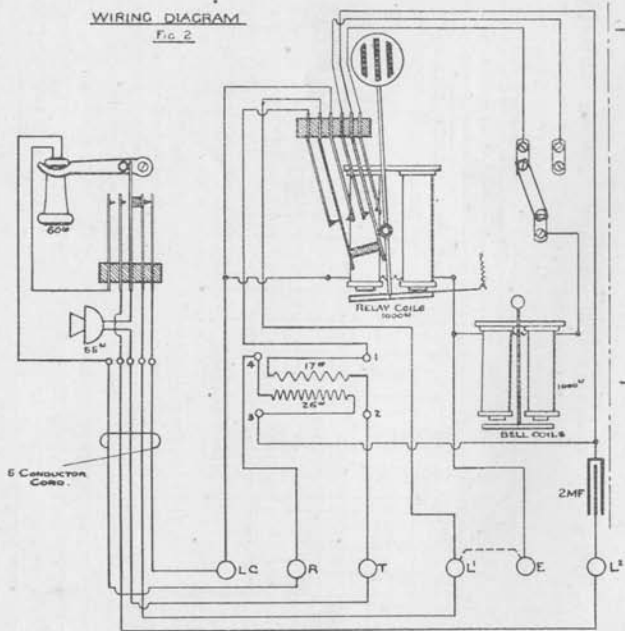

Diagram 18.

COMMON BATTERY WALL 2 PARTY LINE

WIRING DIAGRAM

FIG. 2



THEORY OF CONNECTIONS

FIG. 1

TWO PARTY LINE.

COMMON BATTERY
 MAIN SET & EXTENSION SWITCH
 W.E. TYPE

— MAIN SET —

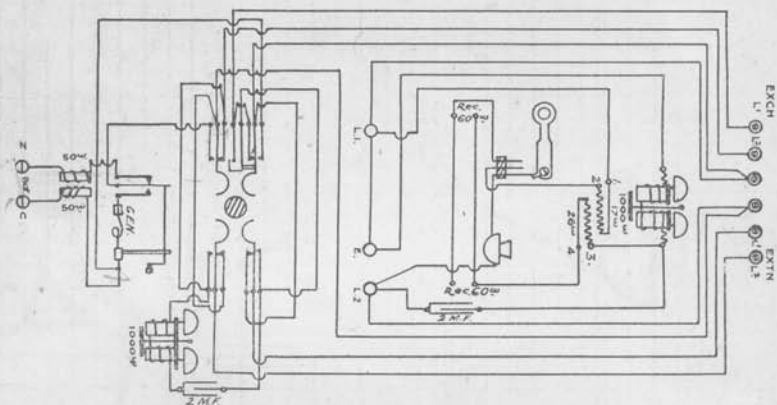

W.E. — EXTENSION SET — WITH GENERATOR

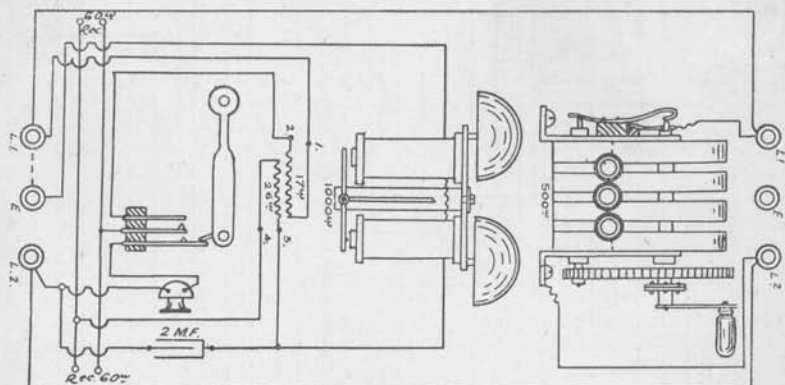

AUTOMATIC WALL
 REE LONG

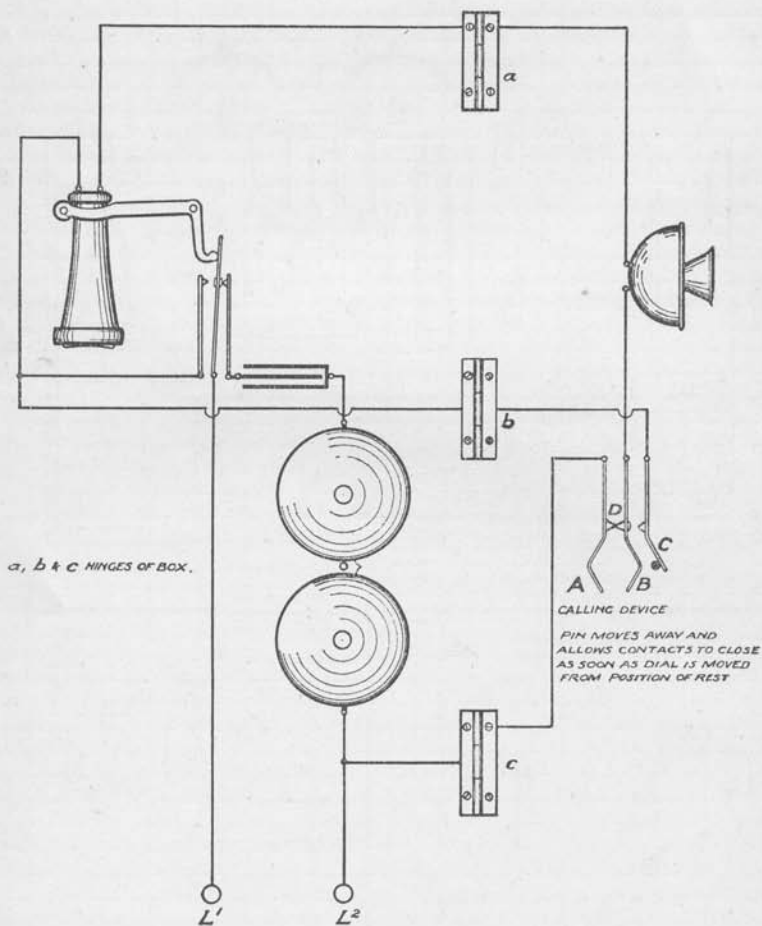
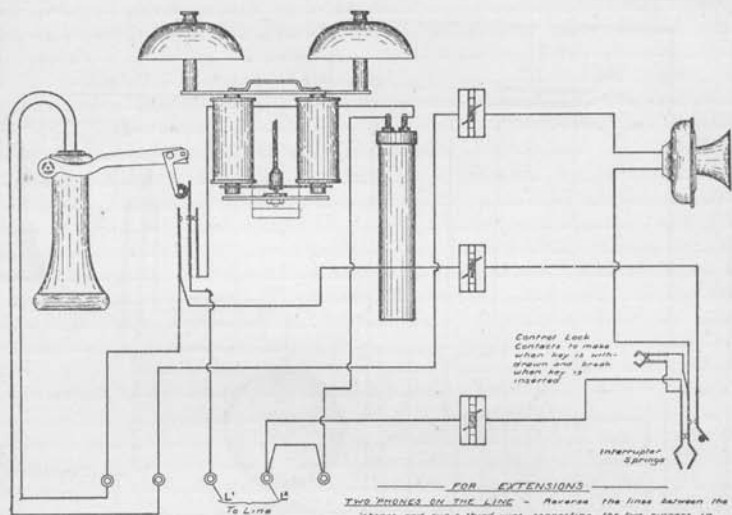

Diagram 21.

AUTOMATIC WALL WITH CONTROL LOCK

AUTOMATIC ELECTRIC COYS TYPE



TWO PHONES ON THE LINE - Reverse the lines between the phones and run a third wire connecting the two ringers in series

MORE THAN TWO PHONES ON THE LINE - Bias the ringers and connect them across the line, so that the operating impulses have no effect on them. Determine the right arrangement by test

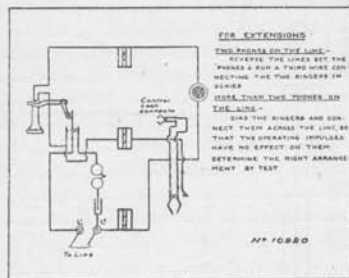

AUTOMATIC WALL PARTY LINE
SEE LONG

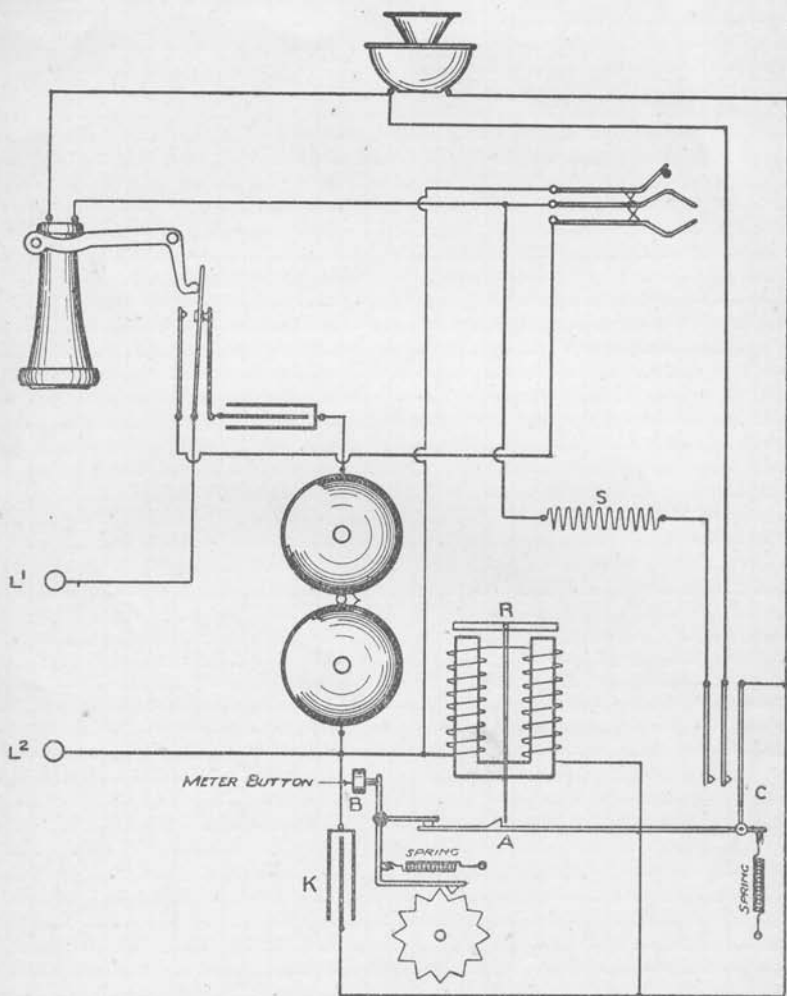
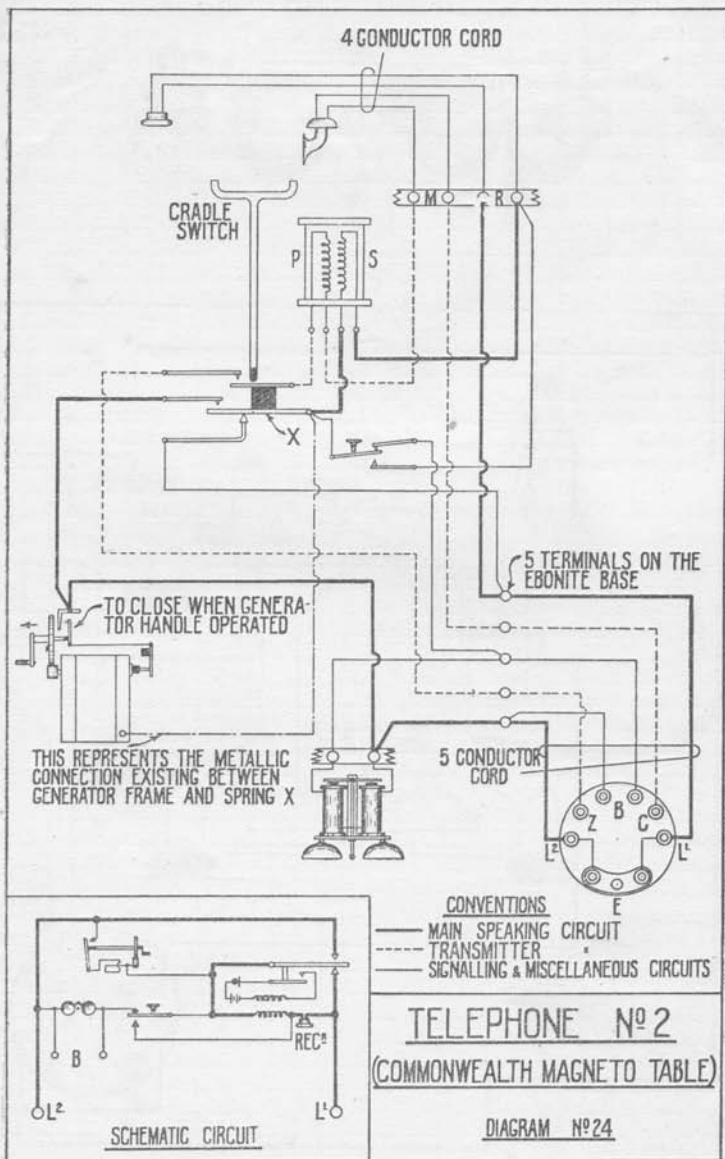

Diagram 23.

SECTION 2.

**Table Telephones—Magneto and
Common Battery.**



Amendment No. 1. Issued 13/12/16.

Diagram 24.

ERIBSSON
TABLE SET

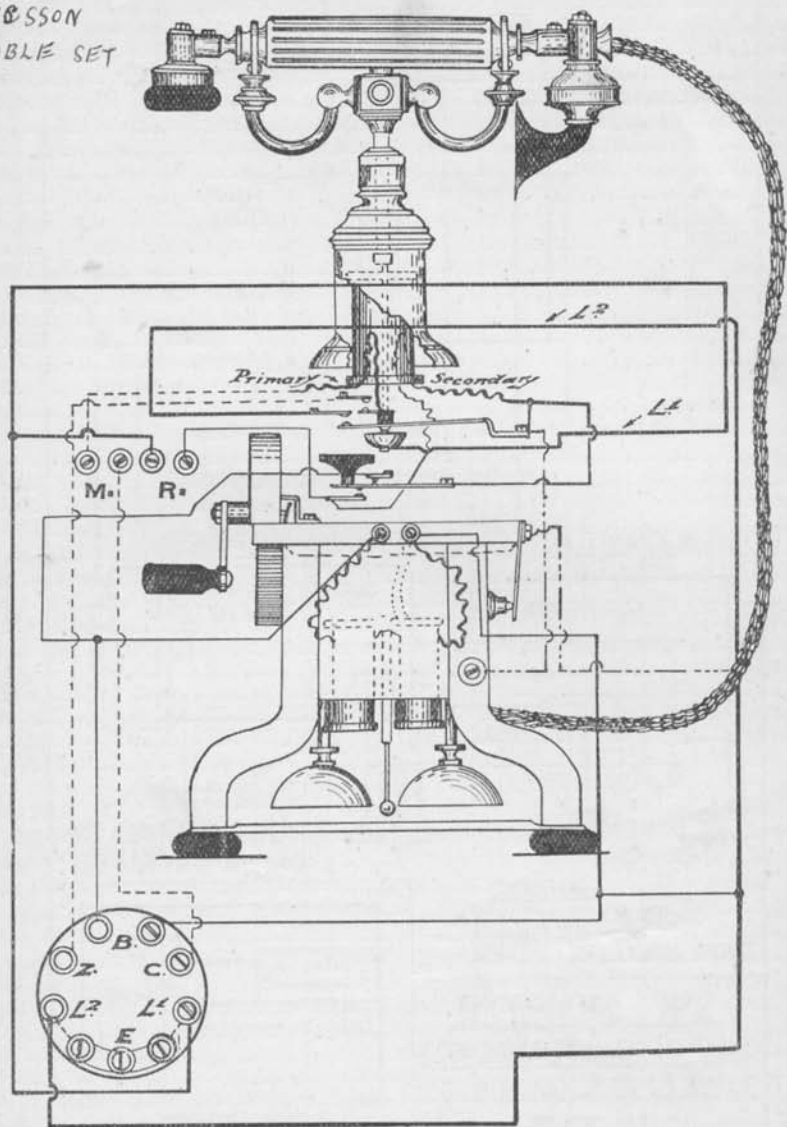
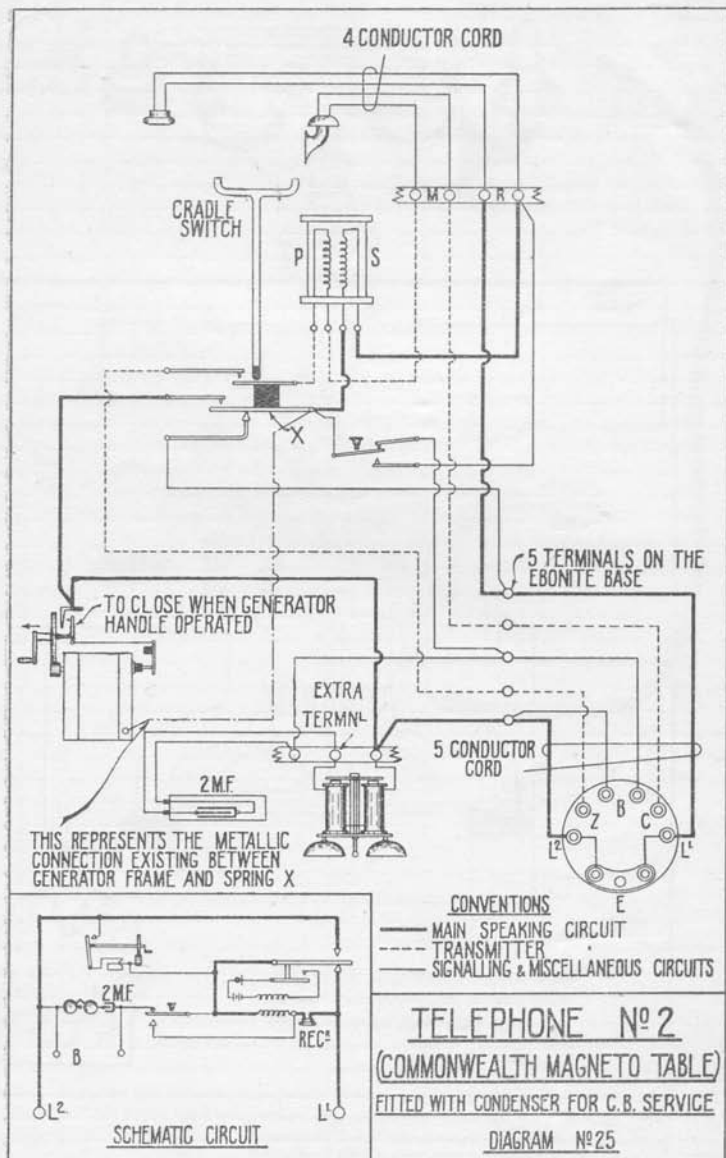

Diagram 24.



Amendment No. 1.

Issued 13/12/16.

Diagram 25.

ERICSSON
 FITTED FOR
 C.B. SERVICE

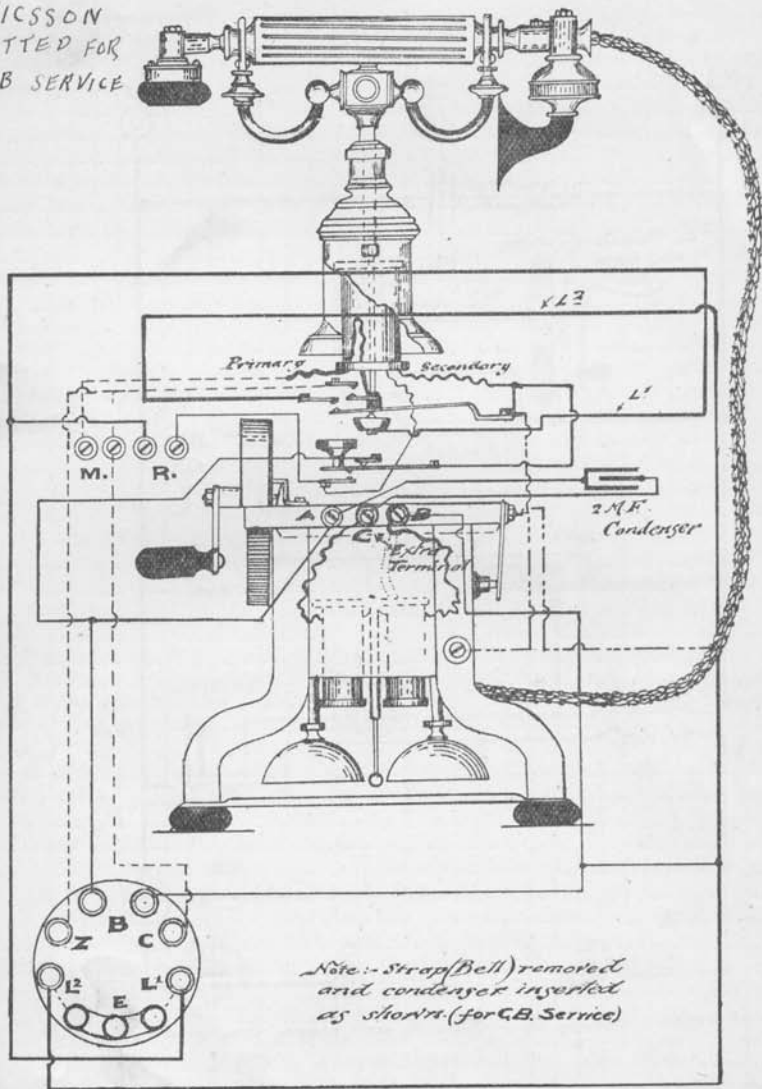

*Note:-- Strap (Bell) removed
 and condenser inserted
 as shown. (for C.B. Service)*

*Note:-- For Magneto Service, the extra
 terminal C and condenser are not required.
 The Bell Coils are connected to Terminals R & B.*

Diagram 25.

COMMONWEALTH MAGNETO
TABLE SCHEMATIC

88

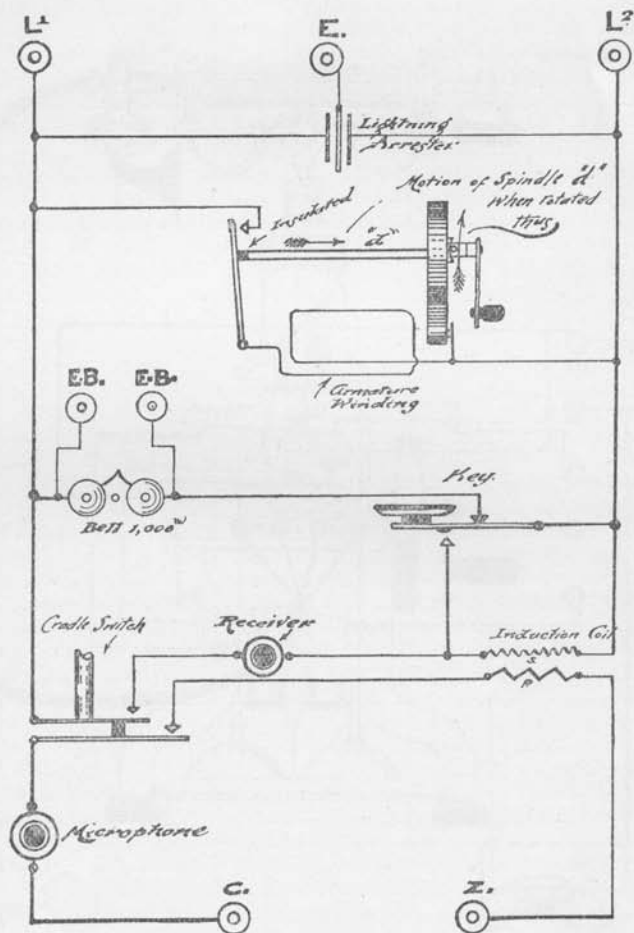

When Generator is idle circuit from L^1 to L^2 through Armature Windings is open.

Diagram 26.

ERRESSON TABLE

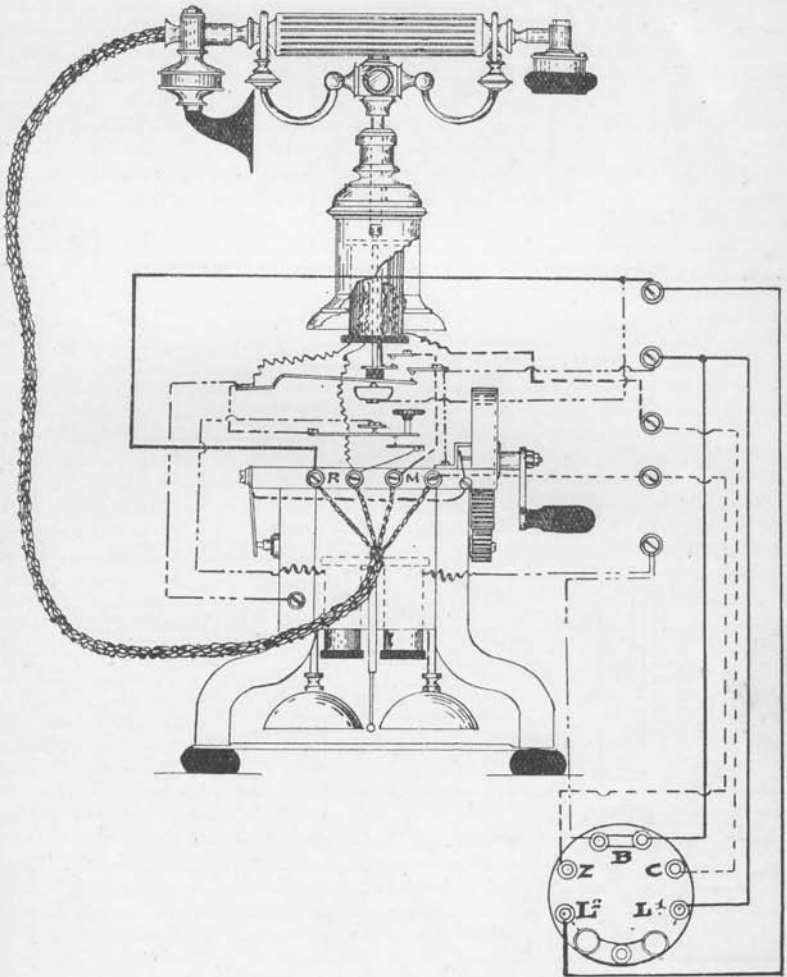

Diagram 27.

ERICSSON

FITTED WITH CONDENSER FOR CB
SERVICE WITHOUT EXTENSION BELL

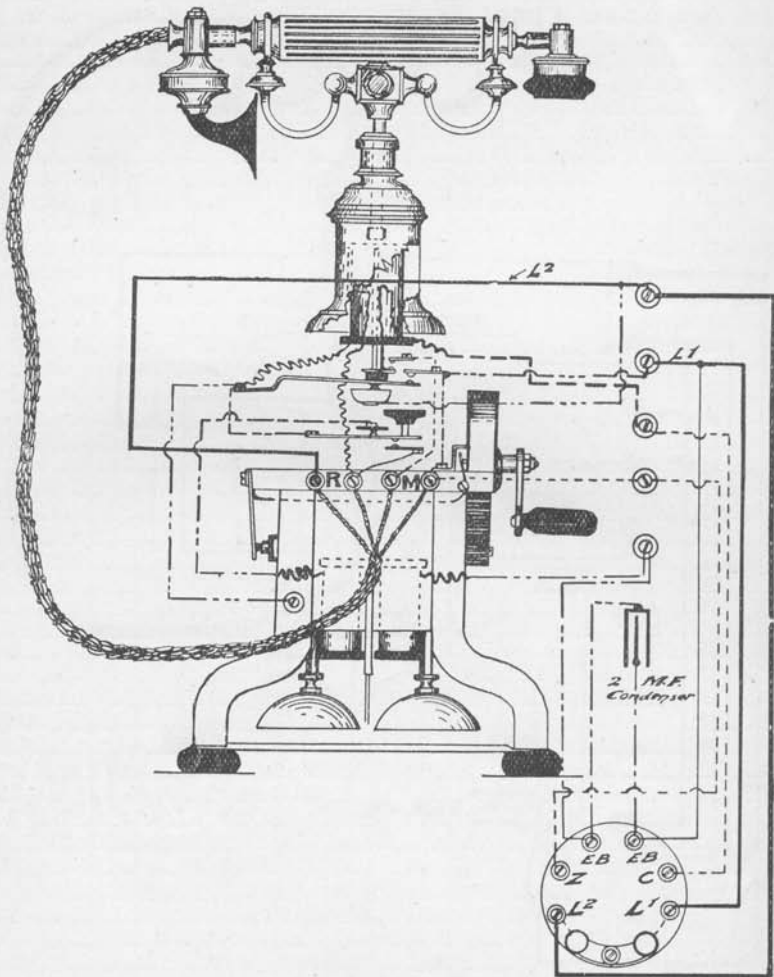

Diagram 28.

ERICSSON
 FITTED WITH CONDENSER FOR C.B.
 SERVICE WITH EXTENSION BELL

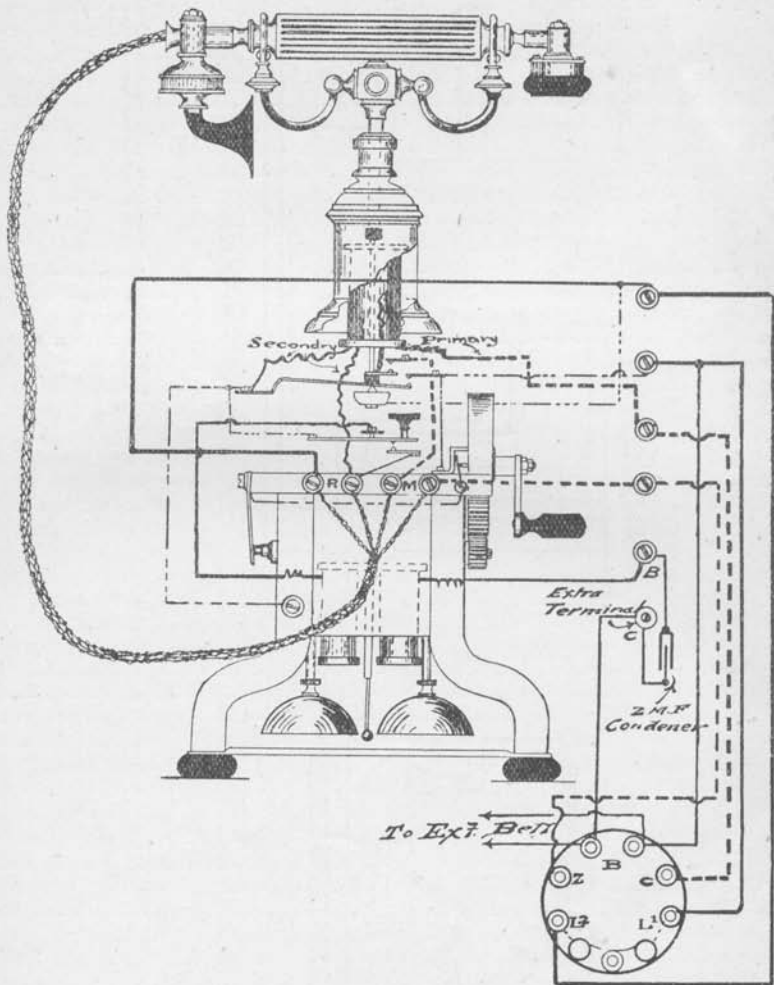
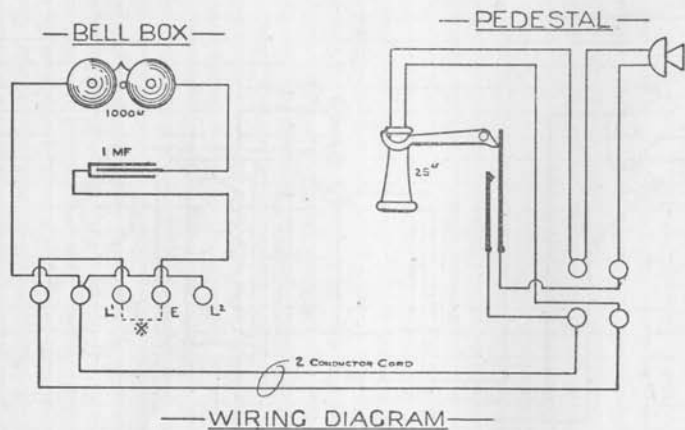
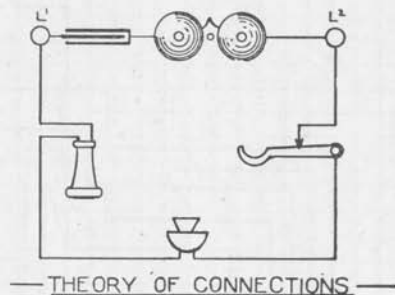

Diagram 29.

COMMON BATTERY SERIES WITH ELECTRO MAGNETIC
RECEIVER Q.E. TYPE



* NB When Extension Bell is installed remove Jumper and connect between L¹ & E.



ERICSSON C.B
TABLE

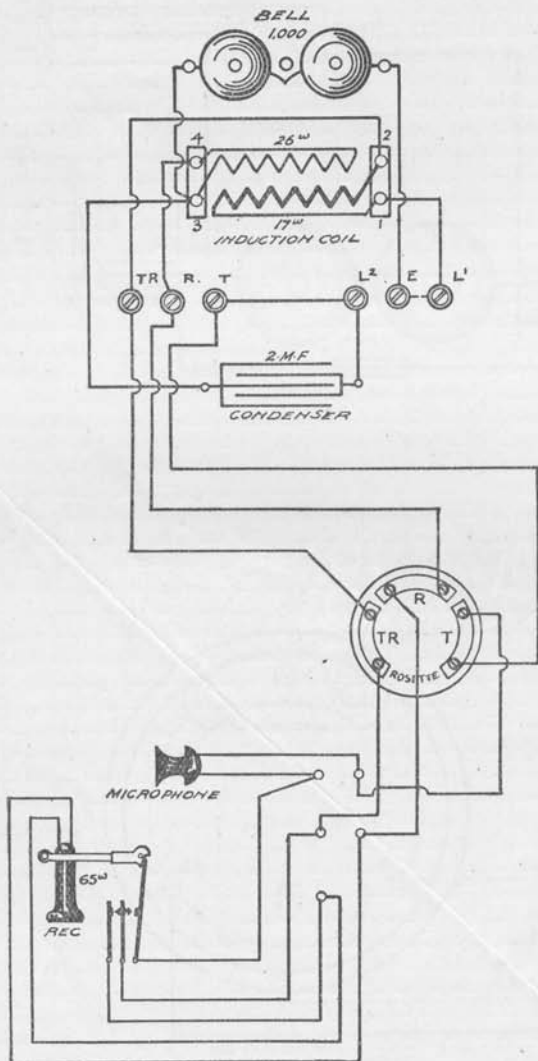

Diagram 31.

ERICSSON C.B.
TABLE

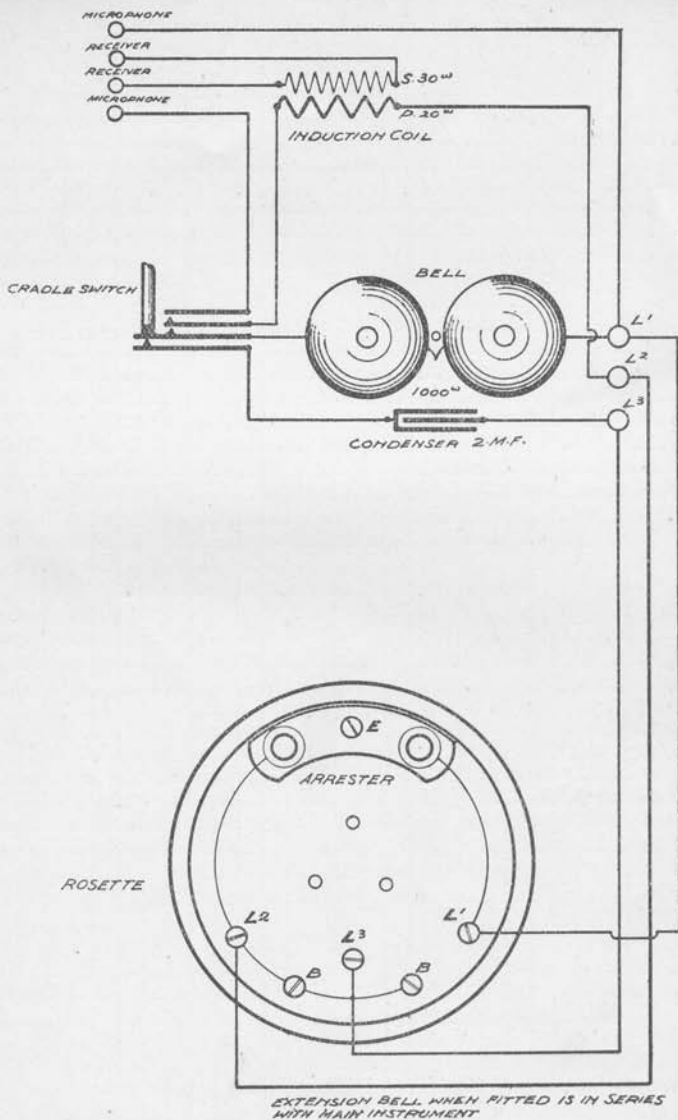
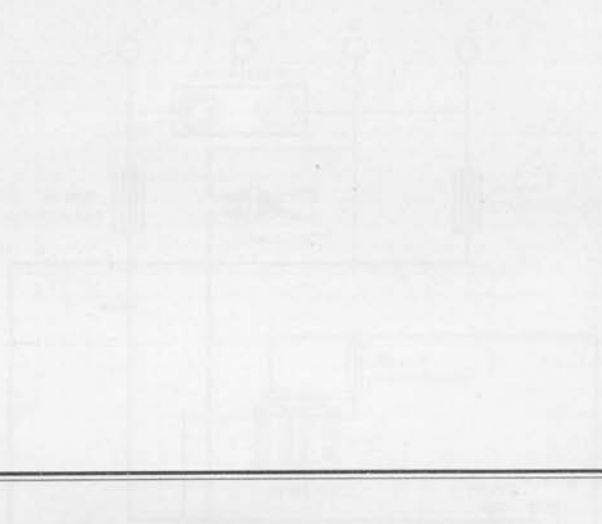
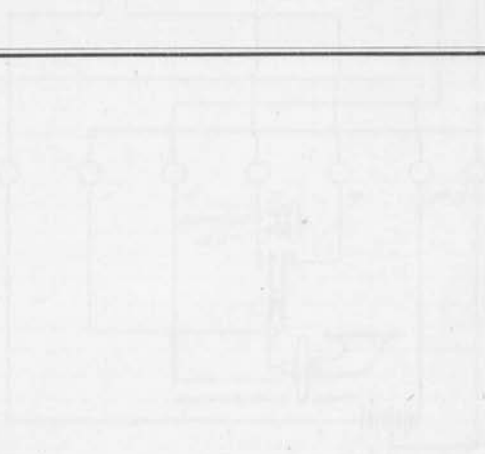

Diagram 32.



SECTION 3.

Telephones for Superimposed Circuits.



ERICSSON CONDENSER
TYPE

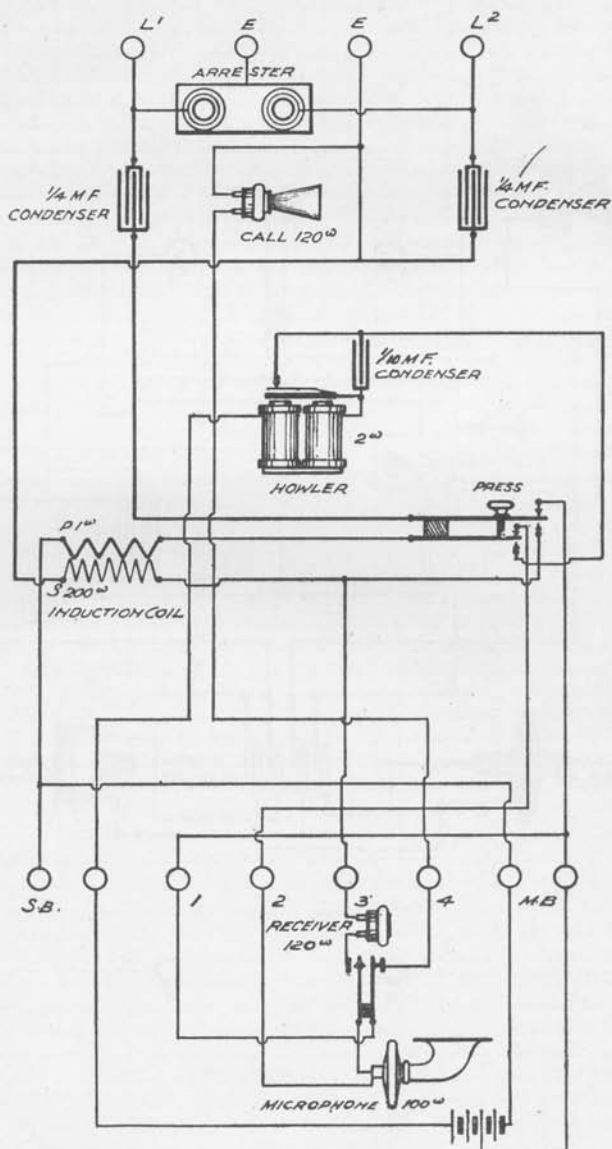

Diagram 33.

CONDENSER . BUZZER

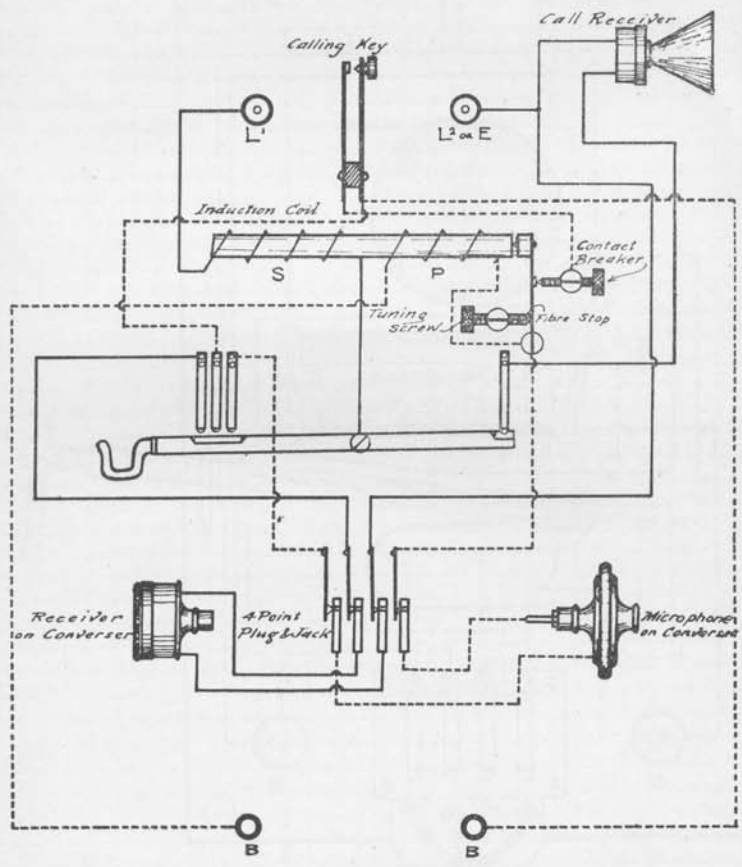
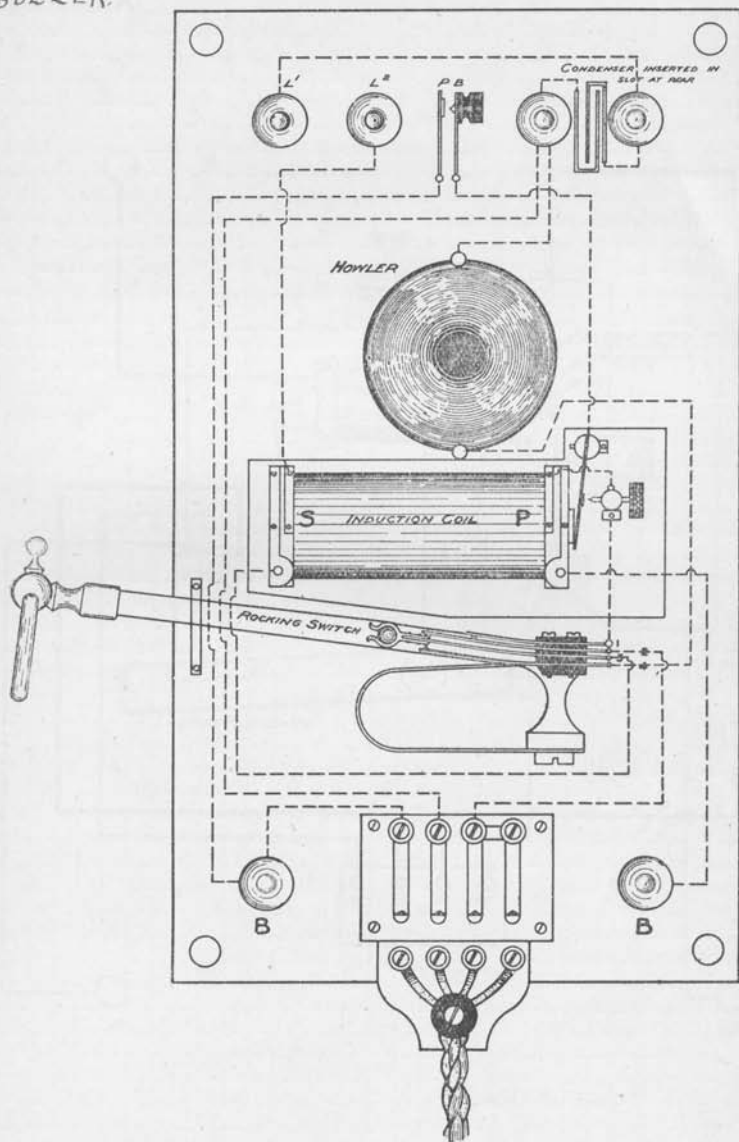

Diagram 34.

CLOSED CIRCUIT
BUZZER.



OPEN CIRCUIT
BOZZER.

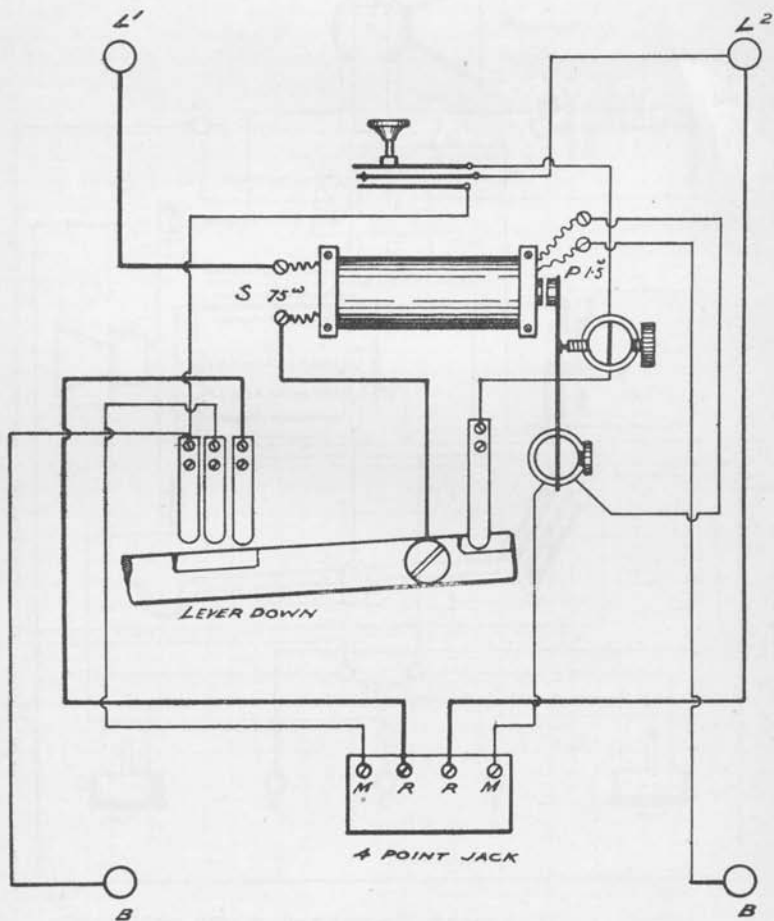
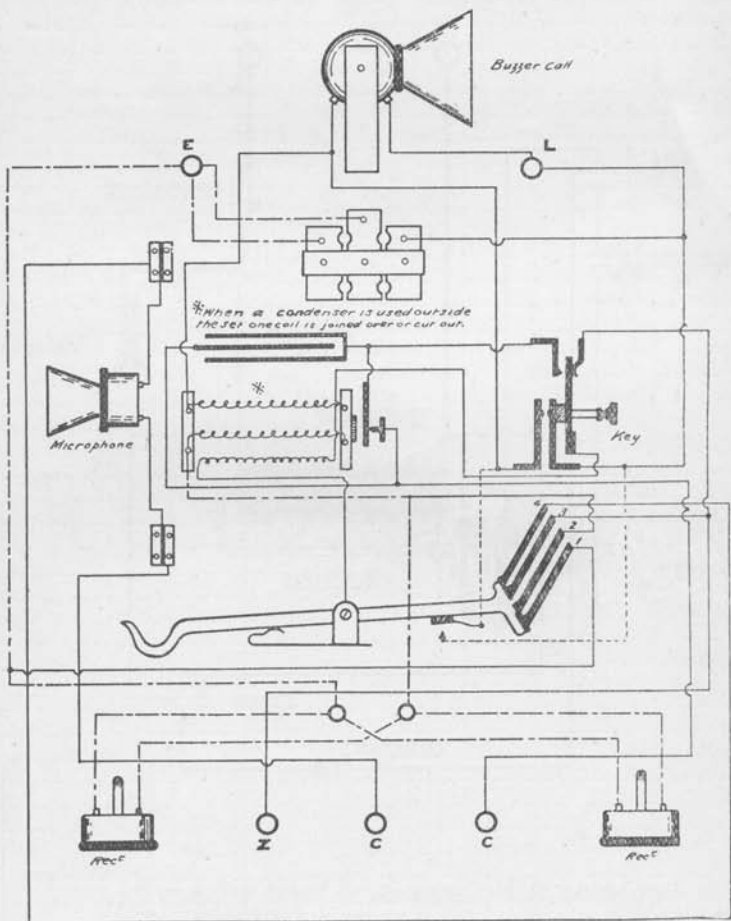

Diagram 36.

PHONOPHORE



Switch down N^o 1, 2 and 3 contact, 4 open

Switch up N^o 4 contact, 1, 2 and 3 open

Diagram 37.

PORTABLE
MED HORST CIRCUIT

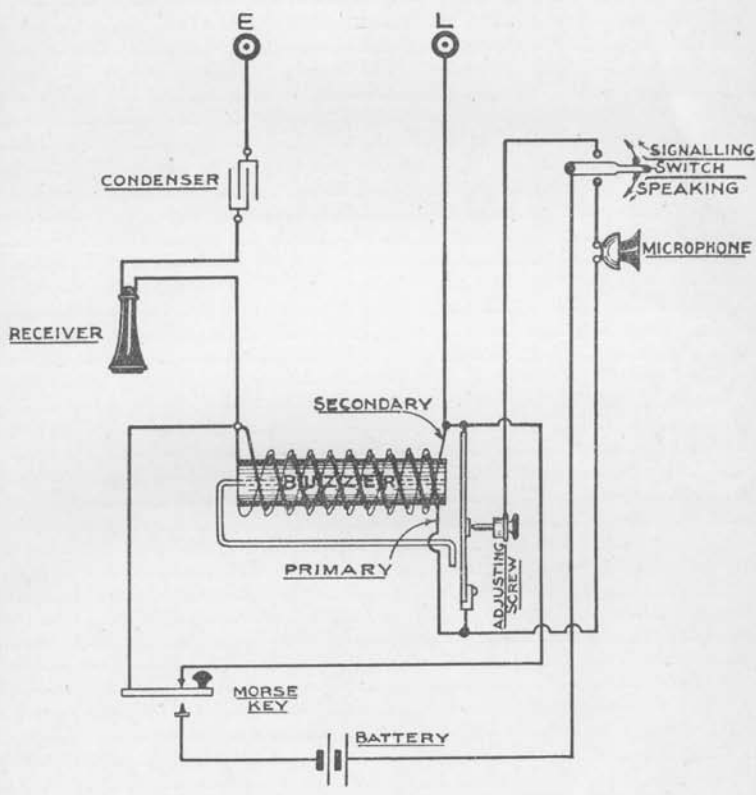

NOTE:- Morse Key must be pressed while speaking -
- or signalling -

Part II.—Switches and Switchboards

SECTION 1.

Switches—Magneto and Common Battery.

ERICSSON MAGNETO
INTERMEDIATE SWITCH

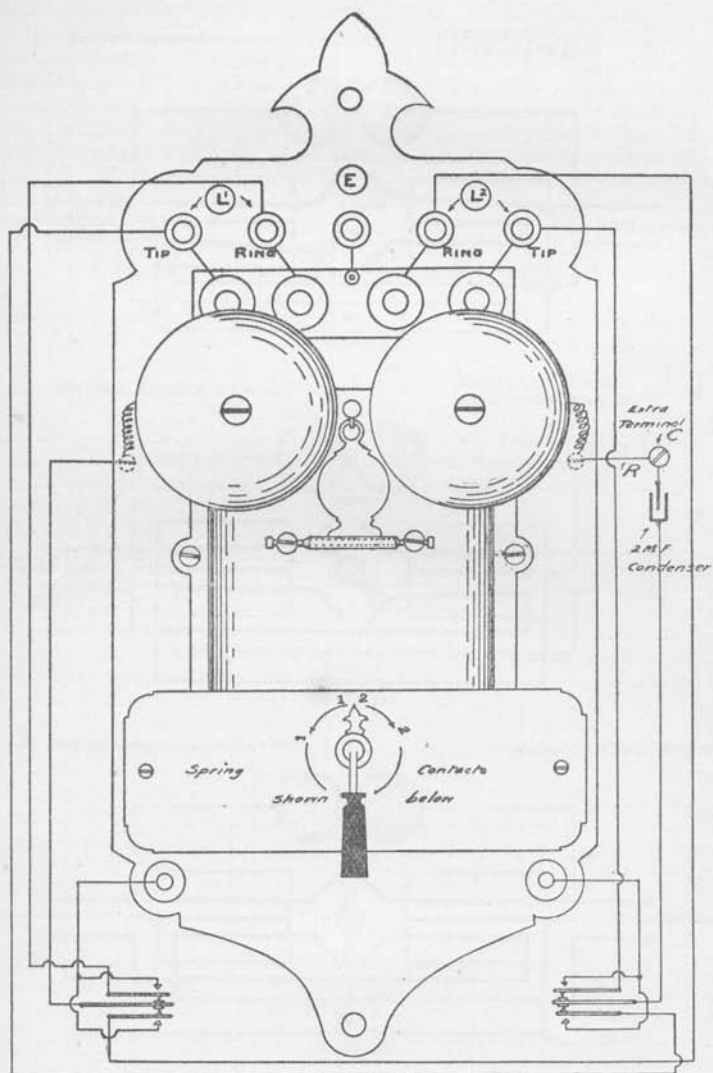
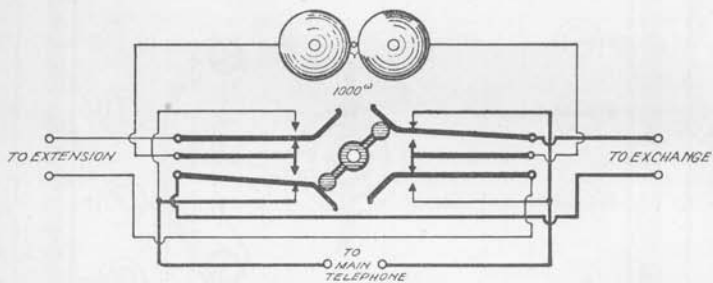

Diagram 39.

ERICSSON THREE POSITIONS

1 SWITCH HANDLE TO LEFT

EXCHANGE TO MAIN
EXTENSION TO BELL



2 SWITCH HANDLE TO RIGHT

EXCHANGE TO BELL
EXTENSION TO MAIN

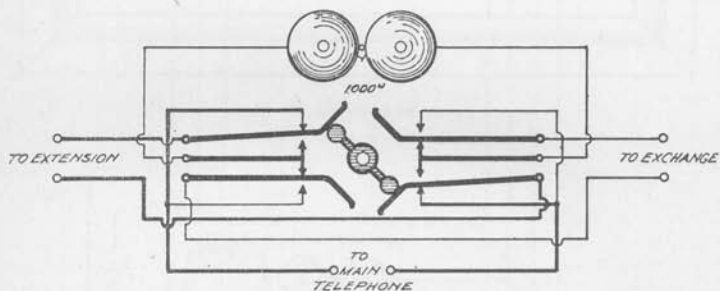

3 SWITCH HANDLE IN CENTRE

EXCHANGE TO EXTENSION

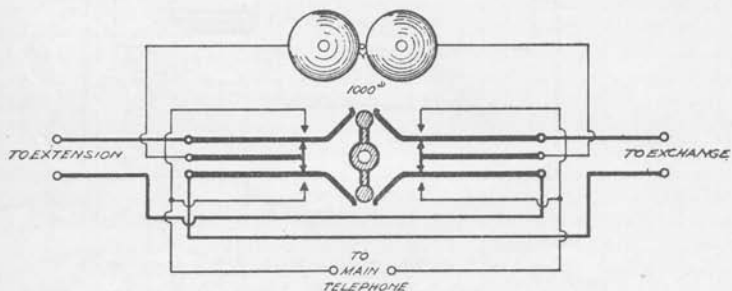

MAGNETO INTERMEDIATE CAPSTAN TYPE
 FITTED WITH CONDENSER FOR C.B. SERVICE

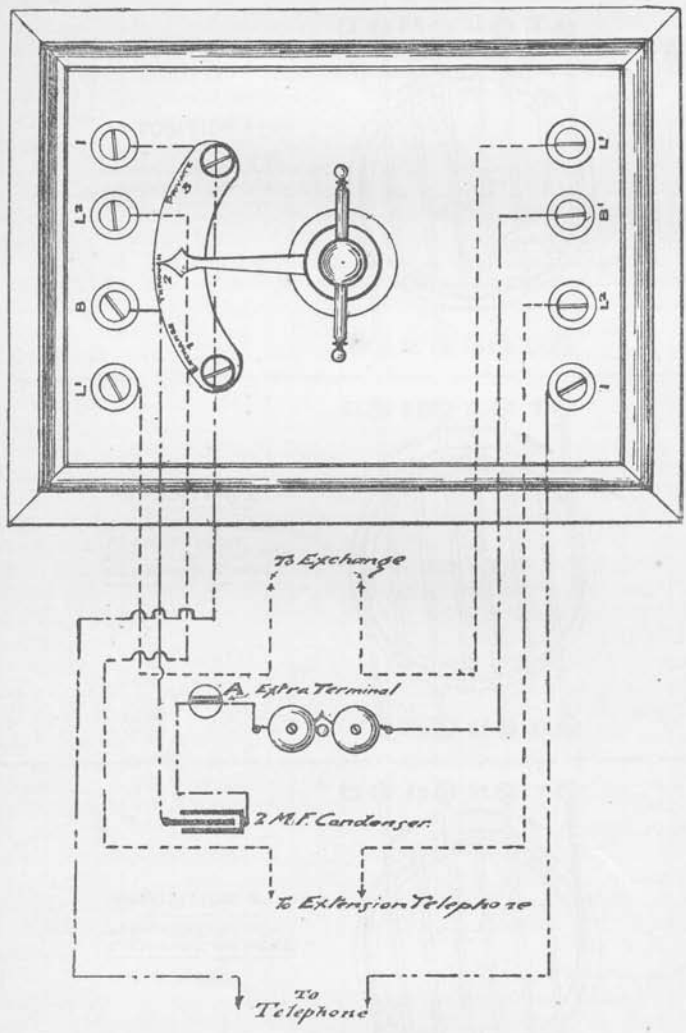

- 1st Position - L¹ to Instrument, L² to Bell.
- 2nd " " - L¹ to L², Bell in Bridge.
- 3rd " " - L² to Instrument, L¹ to Bell.

Diagram 41.

DIAGRAM SHOWING THREE POSITIONS

129

— POSITION 1. —
 MAIN TO EXCHANGE
 EXTENSION (OR PRIVATE
 LINE) ON EXTENSION
 BELL

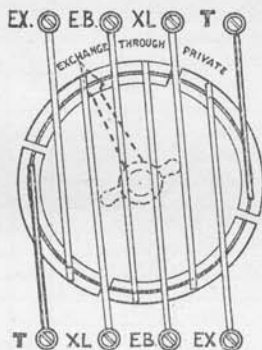

— POSITION 2. —
 EXCHANGE THROUGH
 TO EXTENSION
 BELL IN BRIDGE FOR
 CLEARING SIGNAL

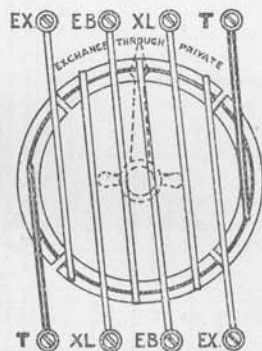

— POSITION 3. —
 MAIN TO EXTENSION
 EXCHANGE ON BELL

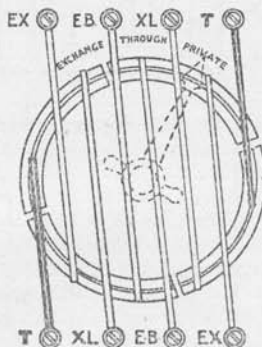

Diagram 42.

COMMON BATTERY SINGLE EXTENSION &
 INTER COMMUNICATION WITH VISUAL SIGNAL
 COMMON WEALTH TYPE.

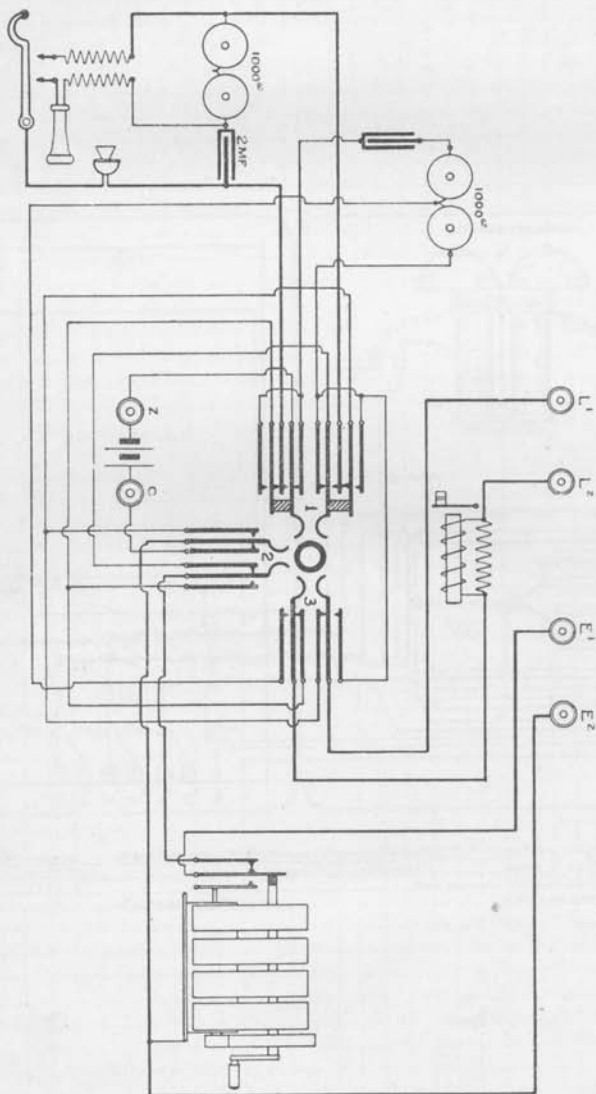
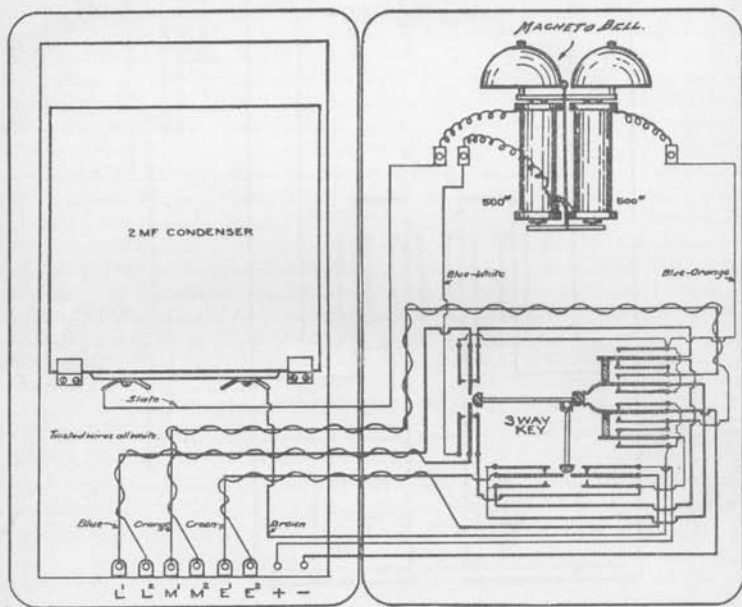

Diagram 43

COMMON BATTERY
INTERMEDIATE B1 TYPE.



KEY NORMAL	Main Telephone to Exchange • Extension Tel on Ext ^m Bell	NORMAL MAIN TO EXCH.
" IN N ^o 1 POS ⁿ	" " " Extension Tel. & Exchange " " "	MAIN TO EXTEN.
" " 1 & 3 "	" " " " " " " held engaged	MAIN TO EXTN. EXCH. HELD
" " 2 "	Exchange to Extension	EXCH. TO EXTEN.

Diagram 44.

COMMON BATTERY
B-1

143

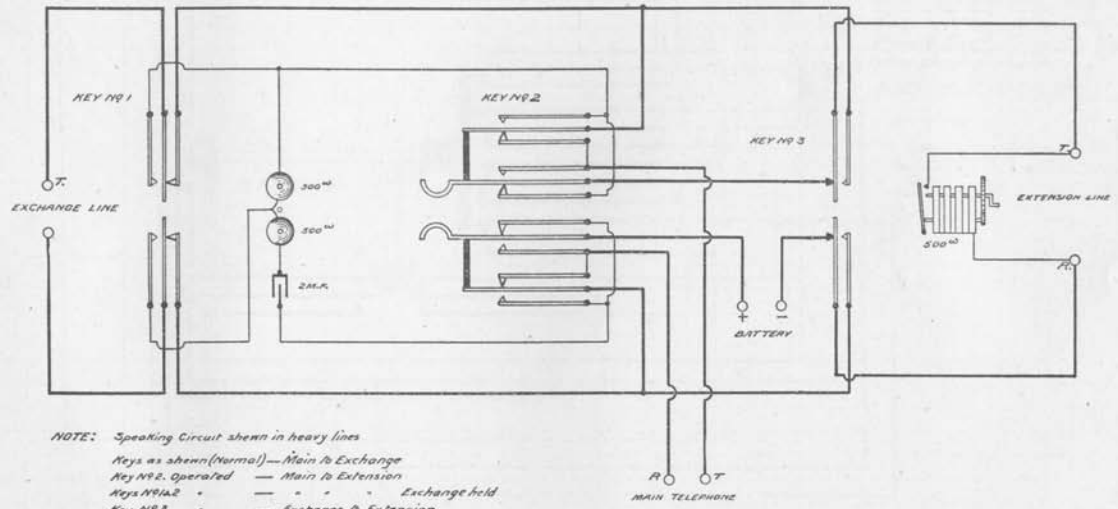
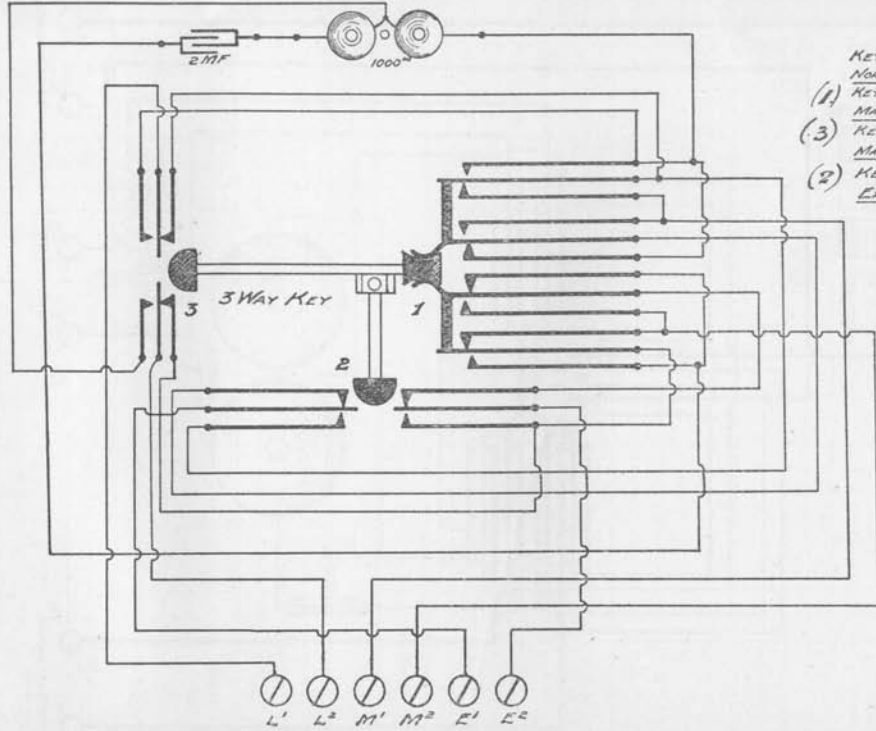

Diagram 45.

COMMON BATTERY

B. 1.



- KEY NORMAL -
NORMAL MAIN TO EXCHANGE
(1) KEY IN N^o 1 POSITION -
MAIN TO EXTENSION
(3) KEY IN N^o 3 POSITION -
MAIN TO EXTⁿ EXCHANGE HELD
(2) KEY IN N^o 2 POSITION -
EXCHANGE TO EXTENSION

Diagram 46.

COMMON BATTERY SINGLE EXTENSION &
 INTER COMMUNICATION WITH VISUAL SIGNAL
 ERICSSON TYPE

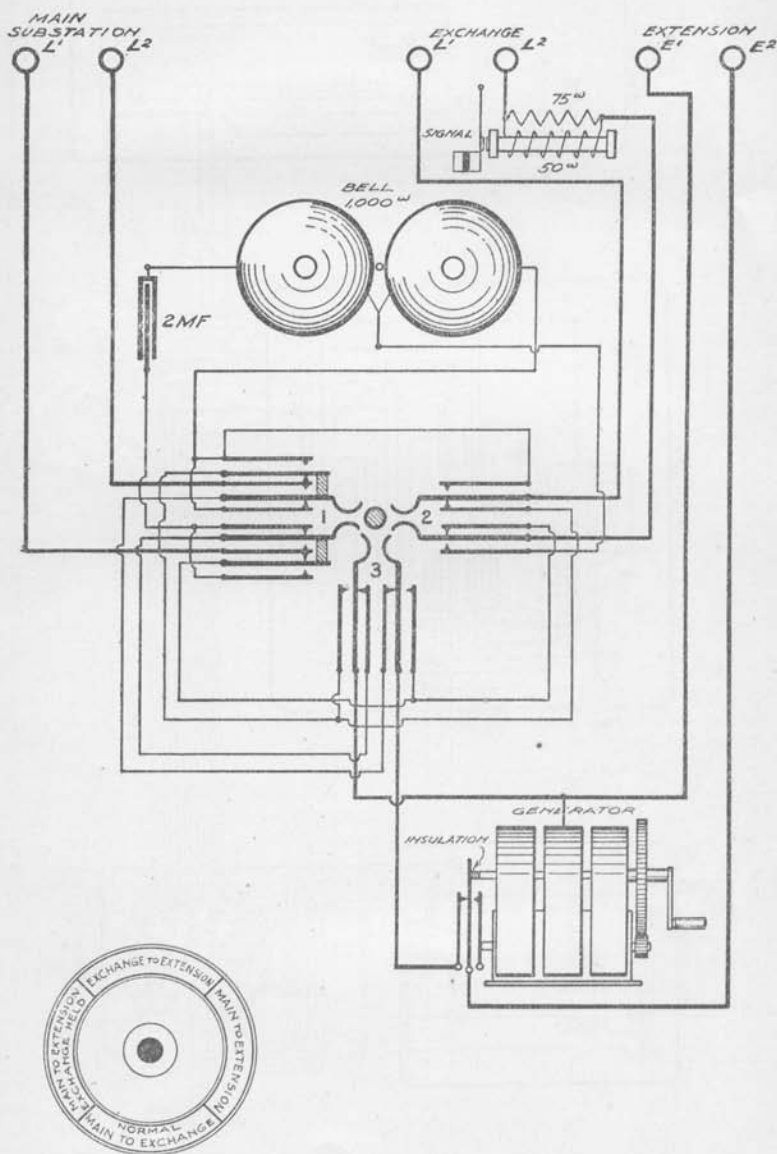

Diagram 47.

COMMON BATTERY
 INTERMEDIATE WITH 1188
 PRESS BUTTONS. W-E TYPE

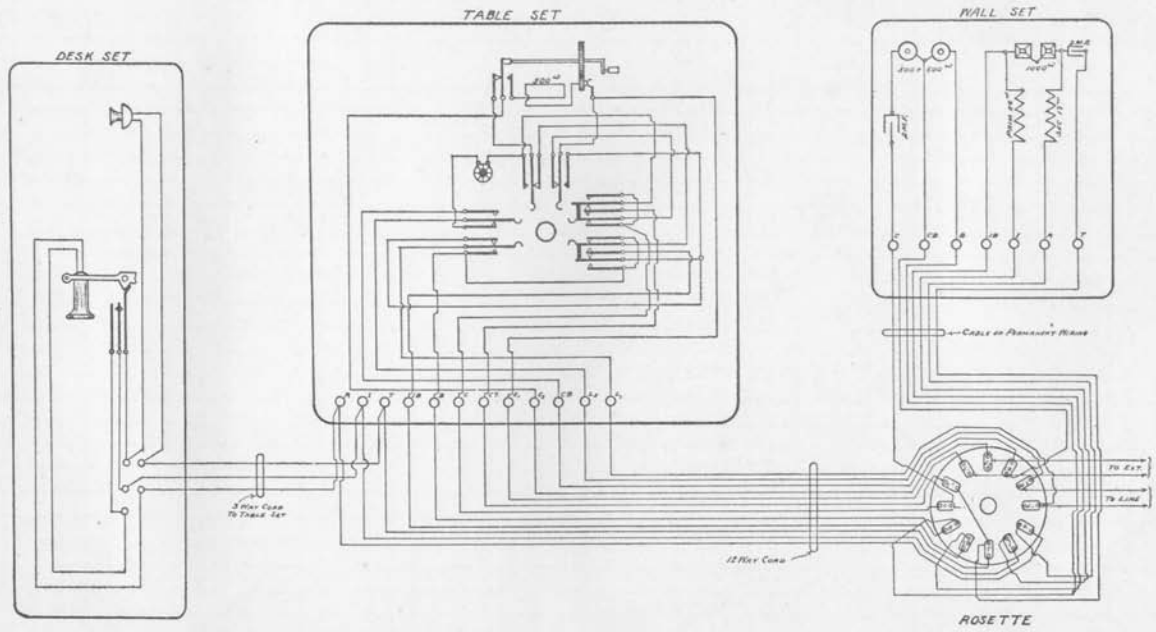

Diagram 48.

SECTION 2.

**Switchboards, Cordless—Magneto and
Common Battery.**

ERICSSON MAGNETO CORDLESS PBX
PYRIMID TYPE

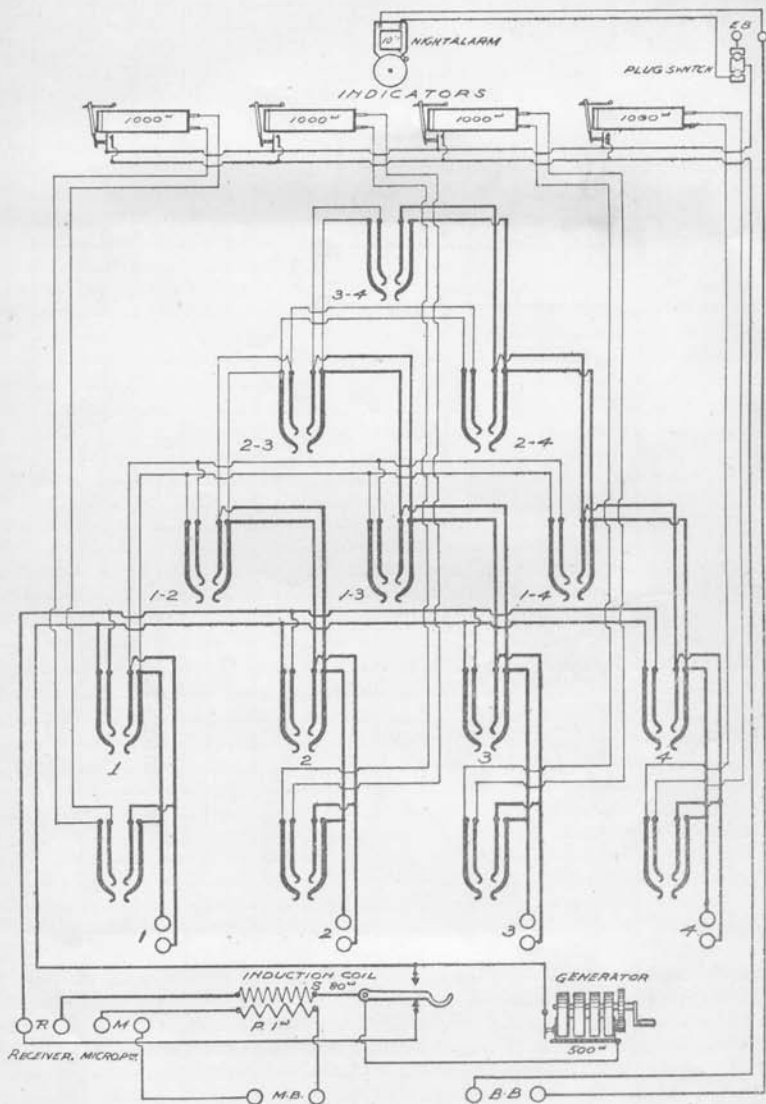

Diagram 49.

MAGNETO P.B.X

10 LINES

W.F. TYPE

Connecting
Cels 1 & 2

Connecting
Cels 3 & 4

Connecting
Cels 5

Generator

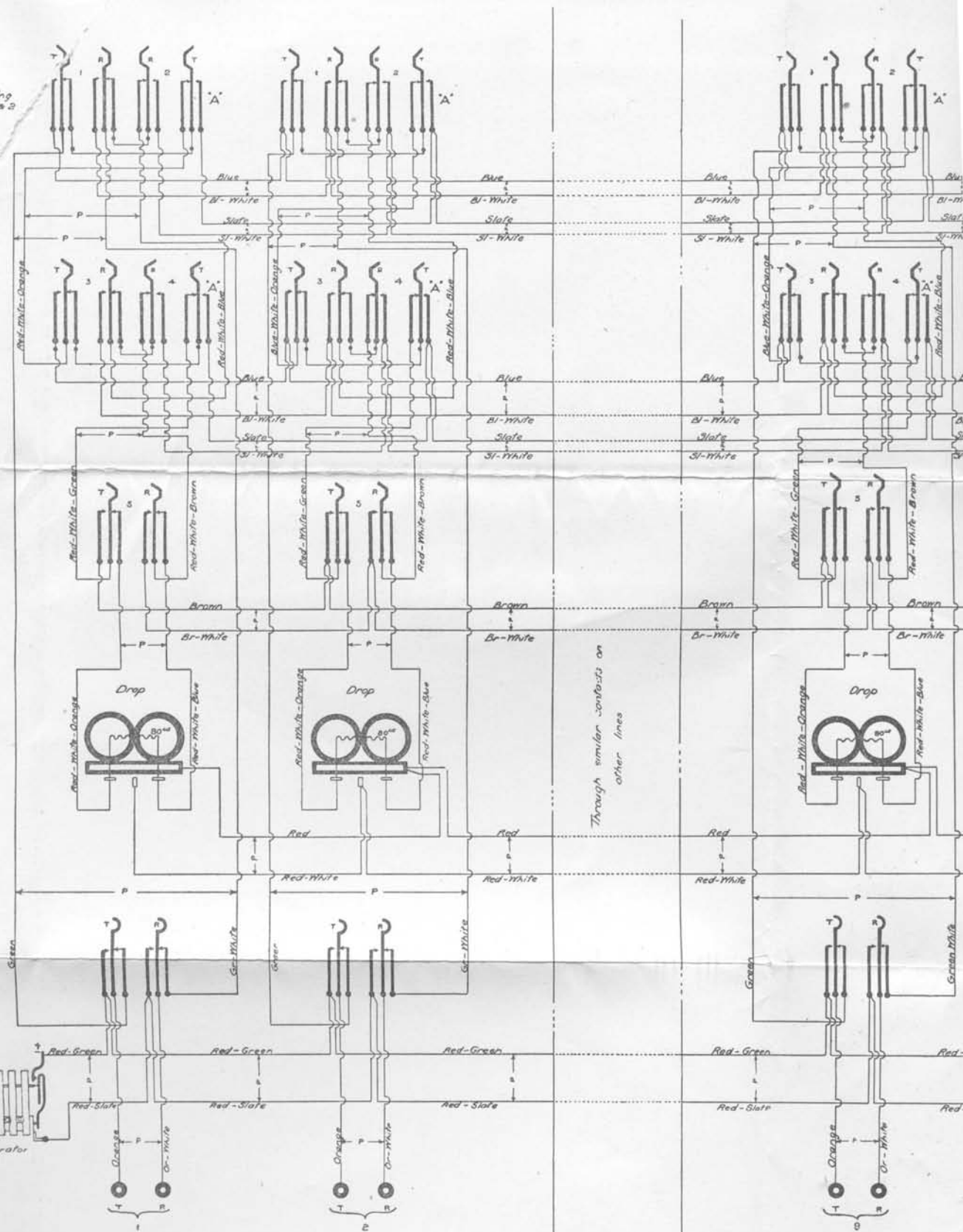

"A" end of Keys nearer top of Board

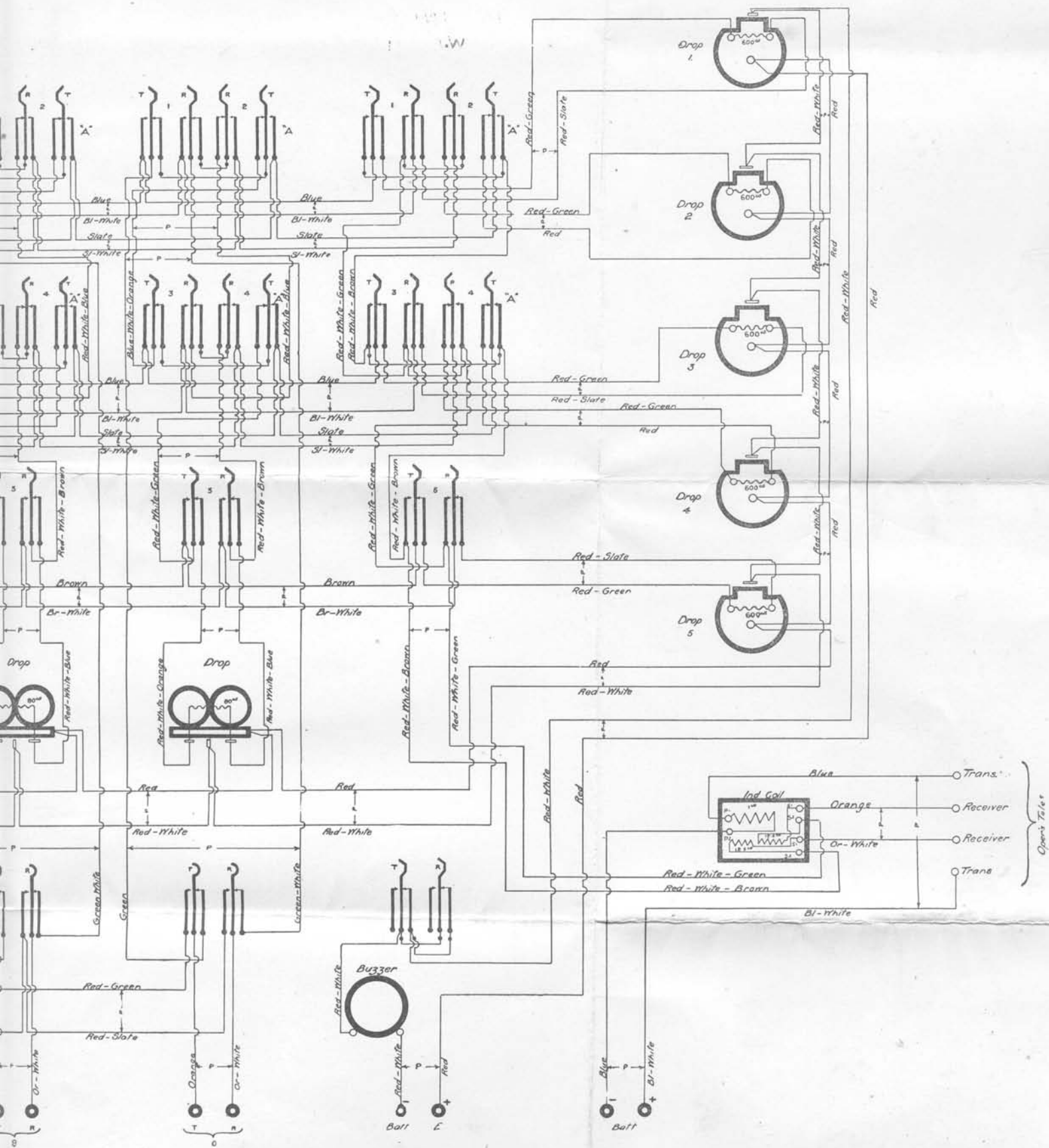

Diagram 50.

ERICSSON C.B. PBX

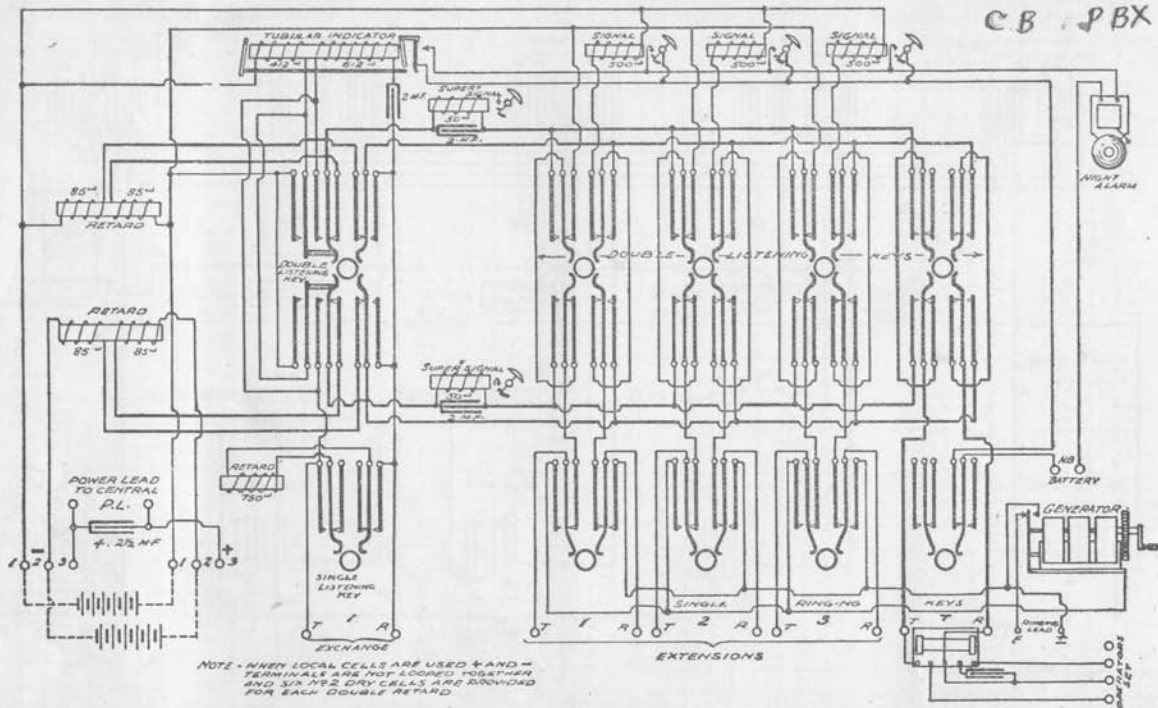

Diagram 51.

C.B. P.B.X. 4 LINES
W.E. TYPE

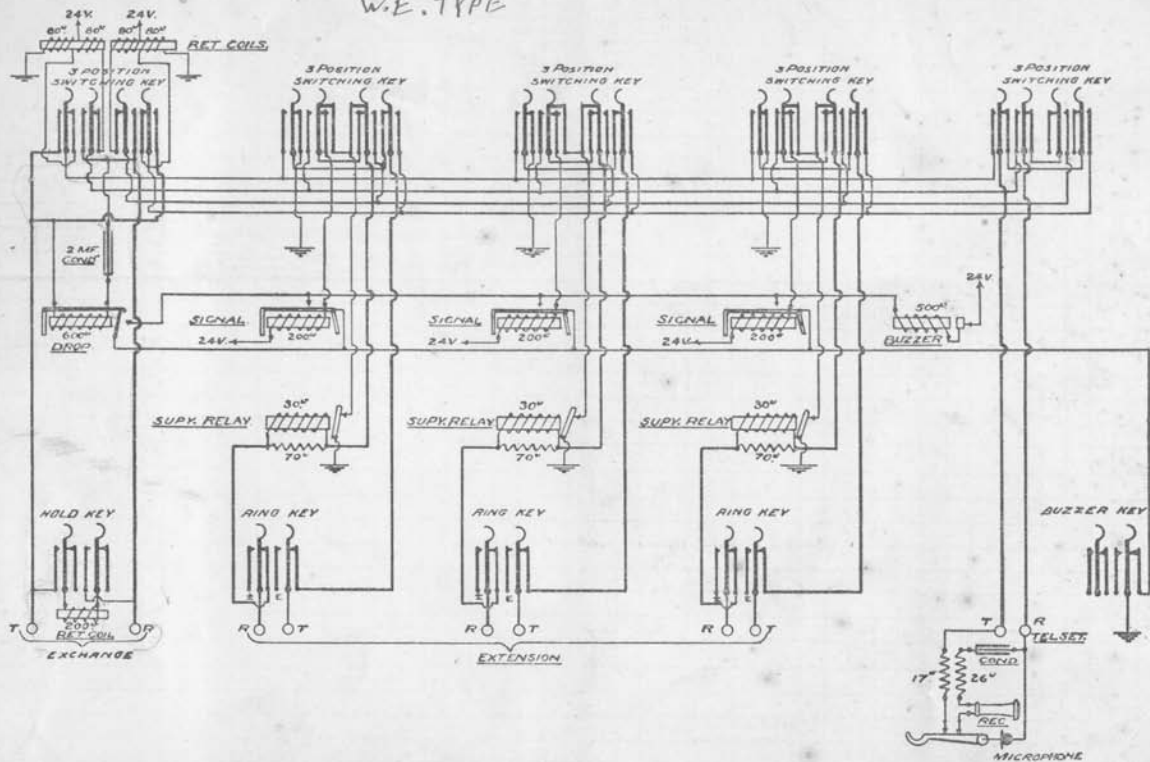
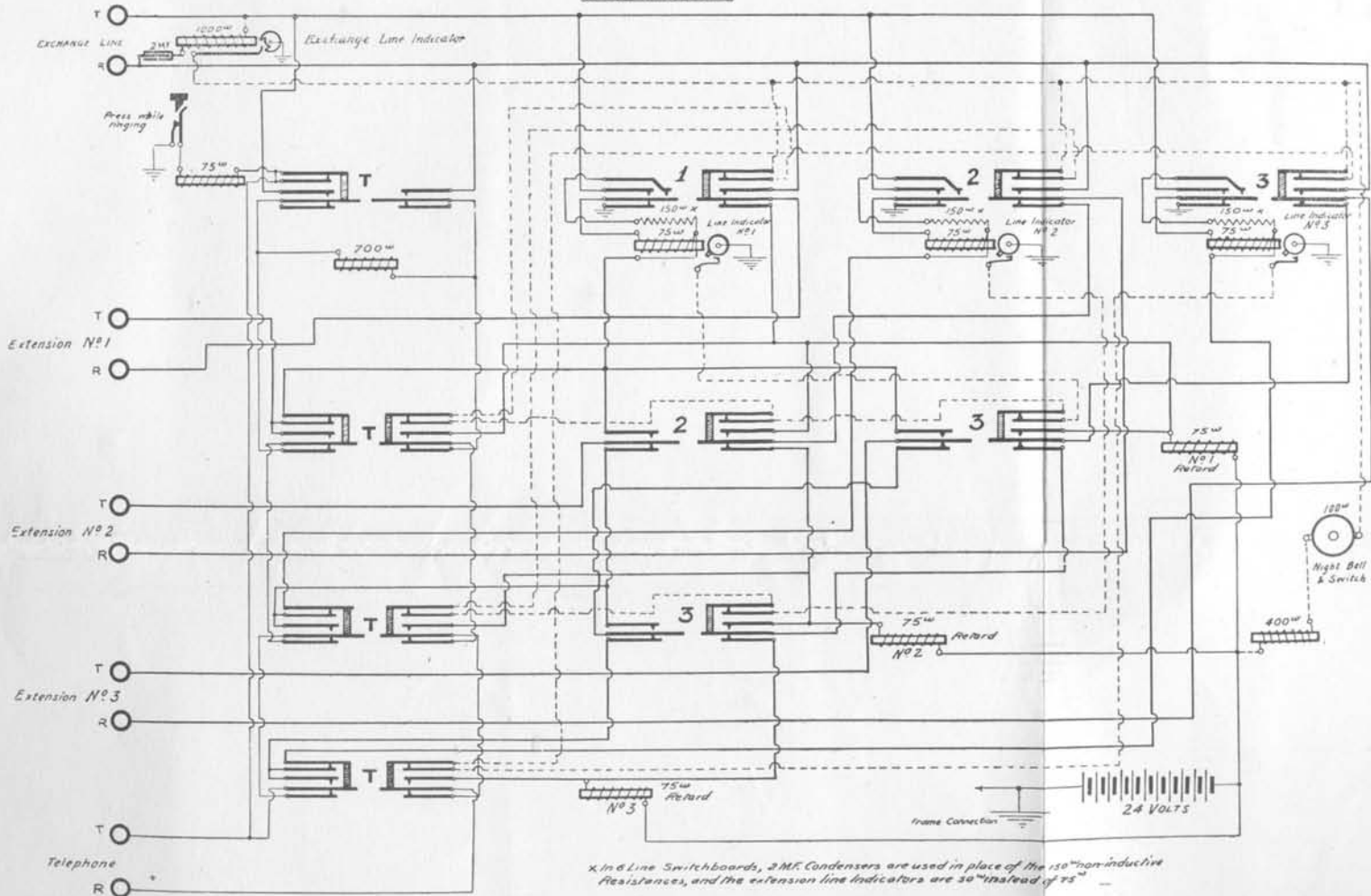

Diagram 52.

C. B P.B.X
 4 LINES B.1 TYPE

I. EXCHANGE LINE
3 EXTENSIONS



x In 6 Line Switchboards, 2 MF. Condensers are used in place of the 150 Ω non-inductive Resistances, and the extension line indicators are 50 Ω instead of 75 Ω

Diagram 53.

SECTION 3.

**Switchboards, Cord—Magneto and
Common Battery.**

CORD P.B.X MAGNETO
 B-1 TYPE 122

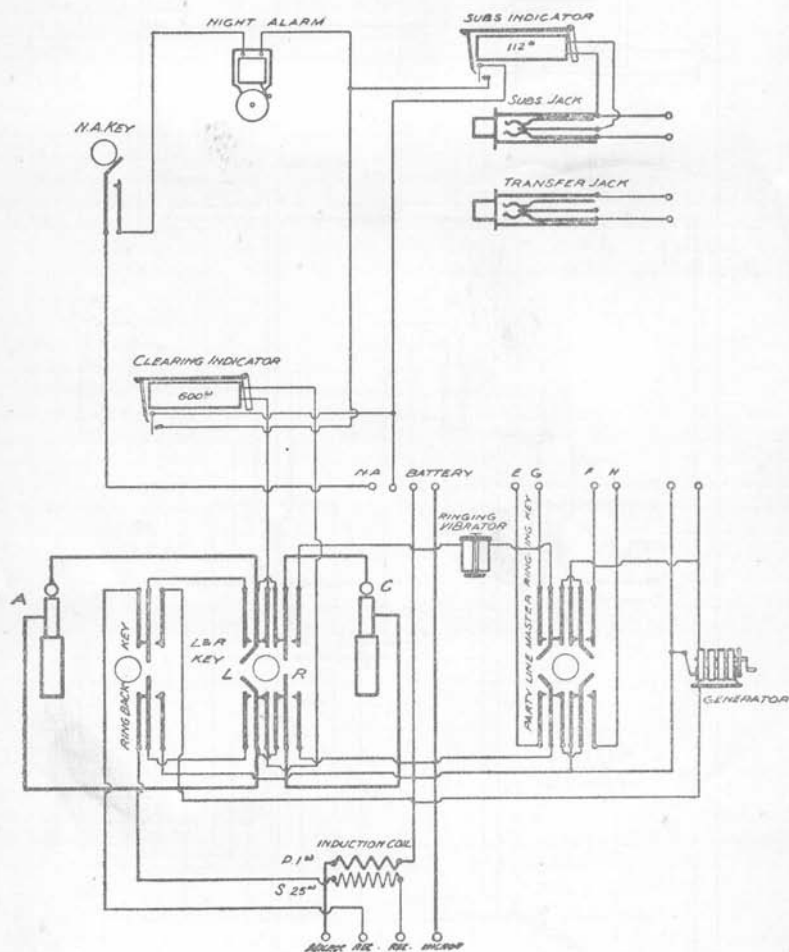

Diagram 54.

CORD P-B. XERICSSON, TYPE

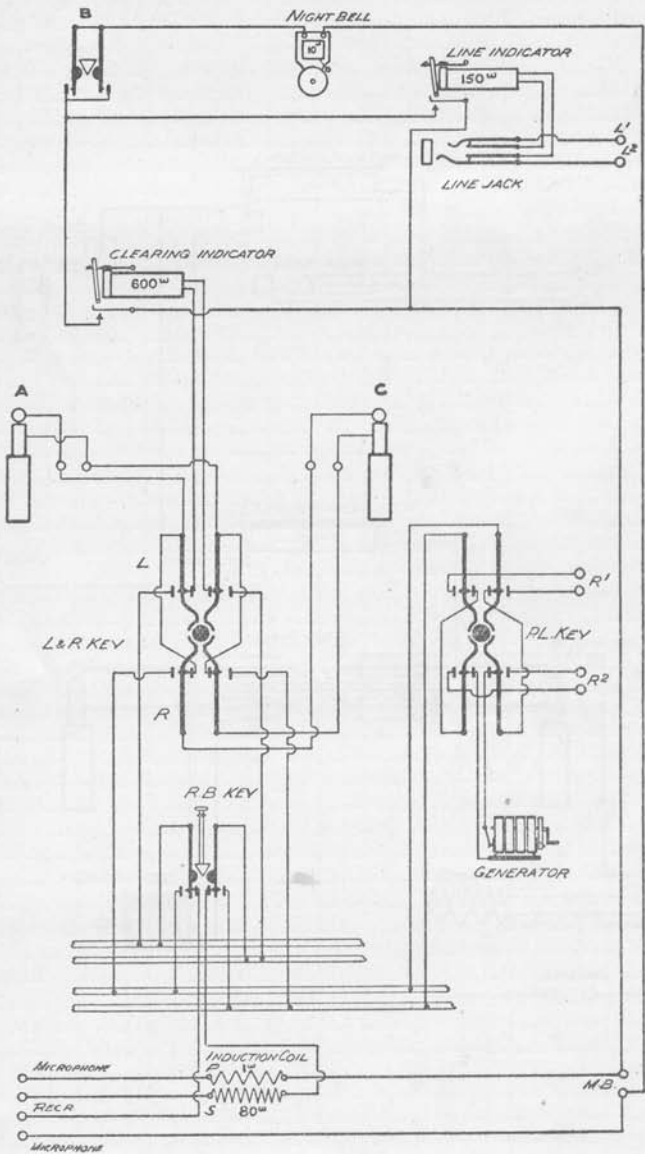

Diagram 55.

CORD P.B.-X
W.E. TYPE

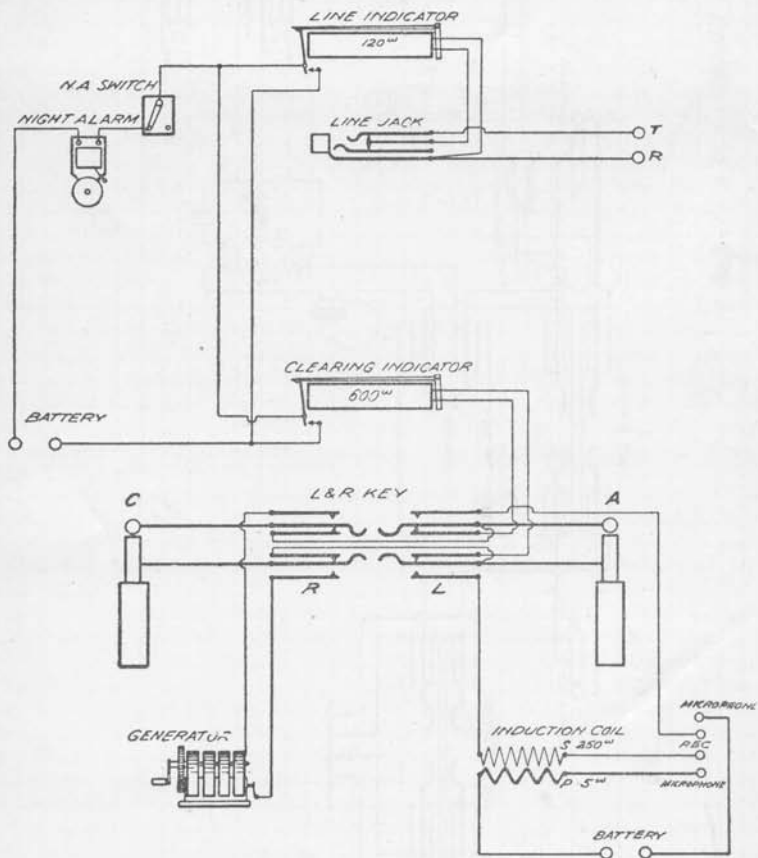

Diagram 56.

50 OR 100 LINE CORD PBX
 W.F. FLOOR PATTERN

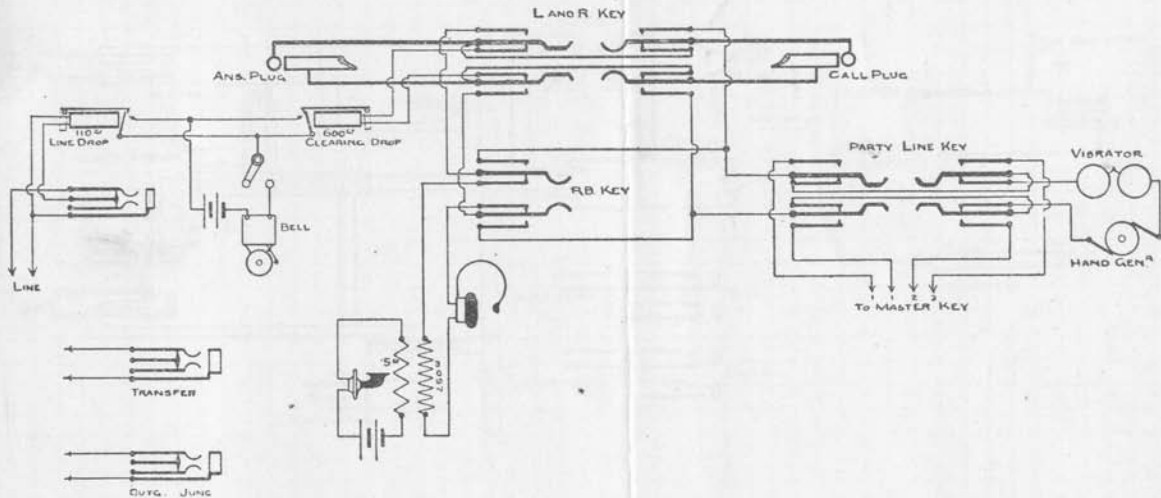

Diagram 57.

NON MULTIPLE
B - POSITION

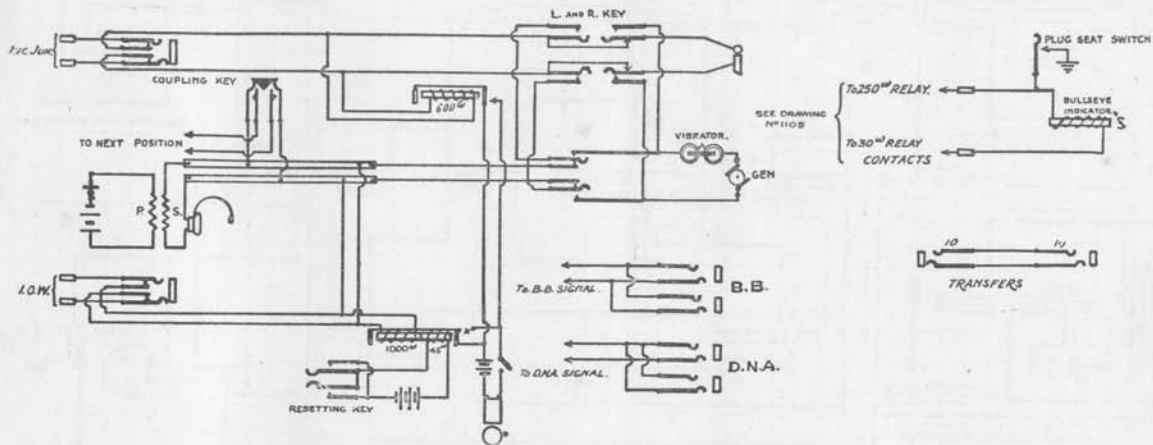

Diagram 58.

COMMON BATTERY CORD P.B.X COMMON WEALTH TYPE

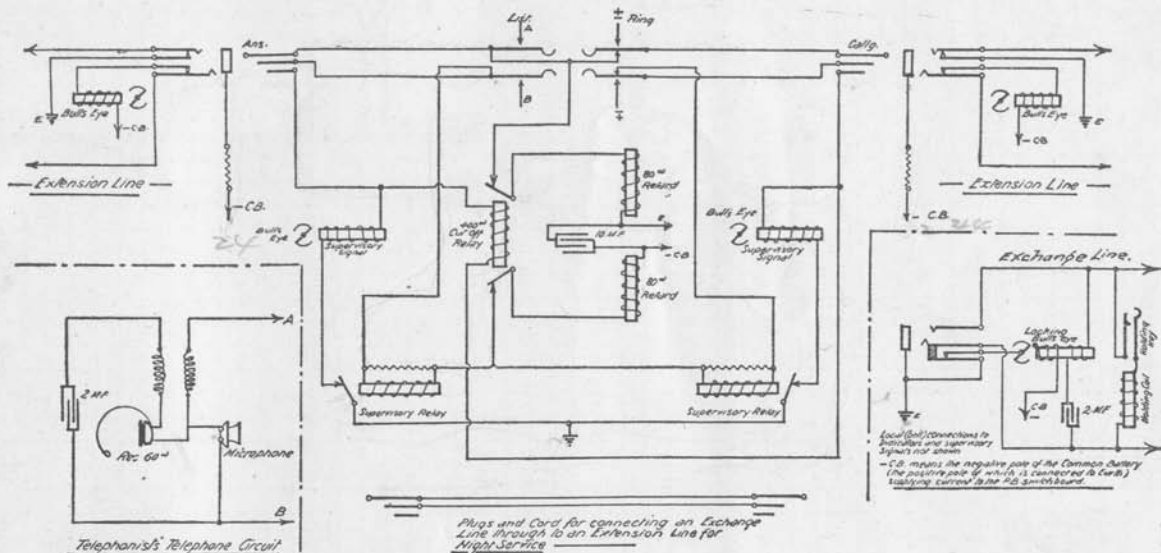

Diagram 59.

c.B. PBX

B-1. TYPE

Extension Line

Each Line
Line Terminal

Night Bell
& Switch

Press Lever of Key Downward
to Answer Exchange's Indicator
Indicator or to Call Exchange
Press Lever of Key Upward
to Abolish Exchange Line while
Operator Calls Answer
Extension Line

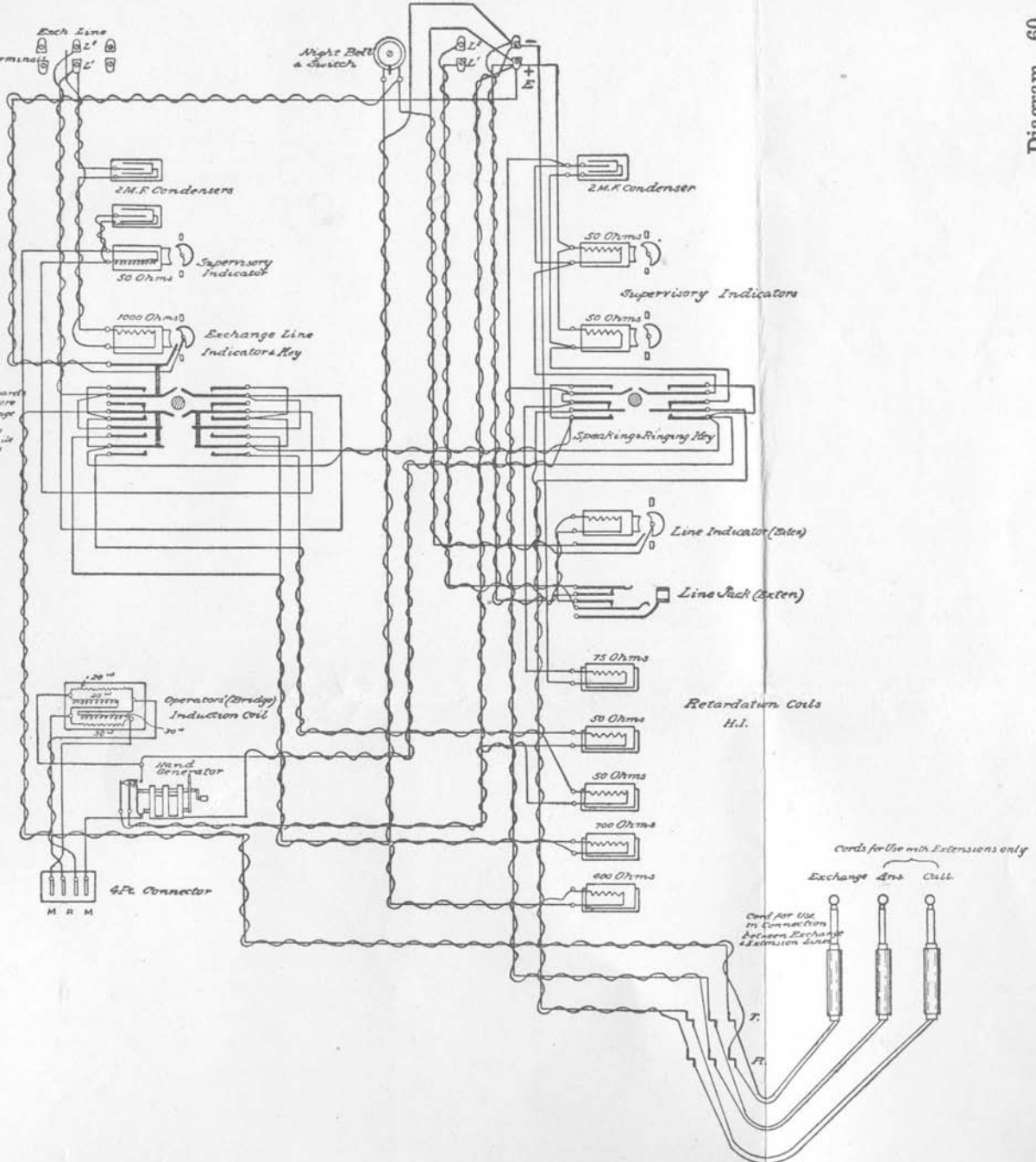

Diagram 60.

C.B. P.B.X. ERISSON TYPE

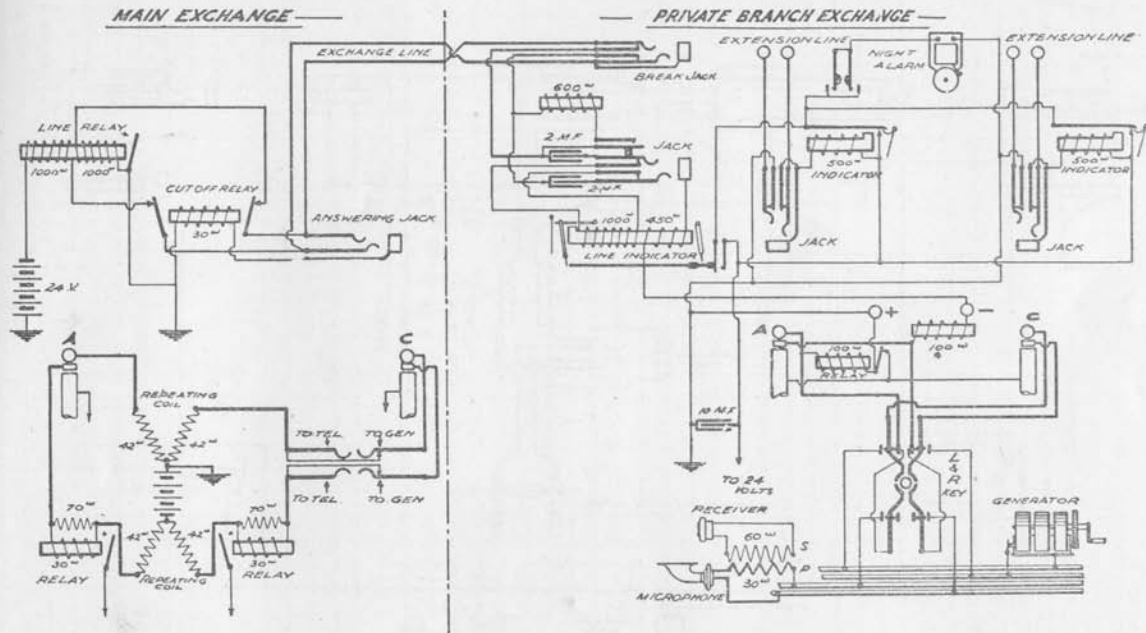

Diagram 61.

C.B. P.B.J.C. WITH EYEBALL
INDICATOR W.E. TYPE

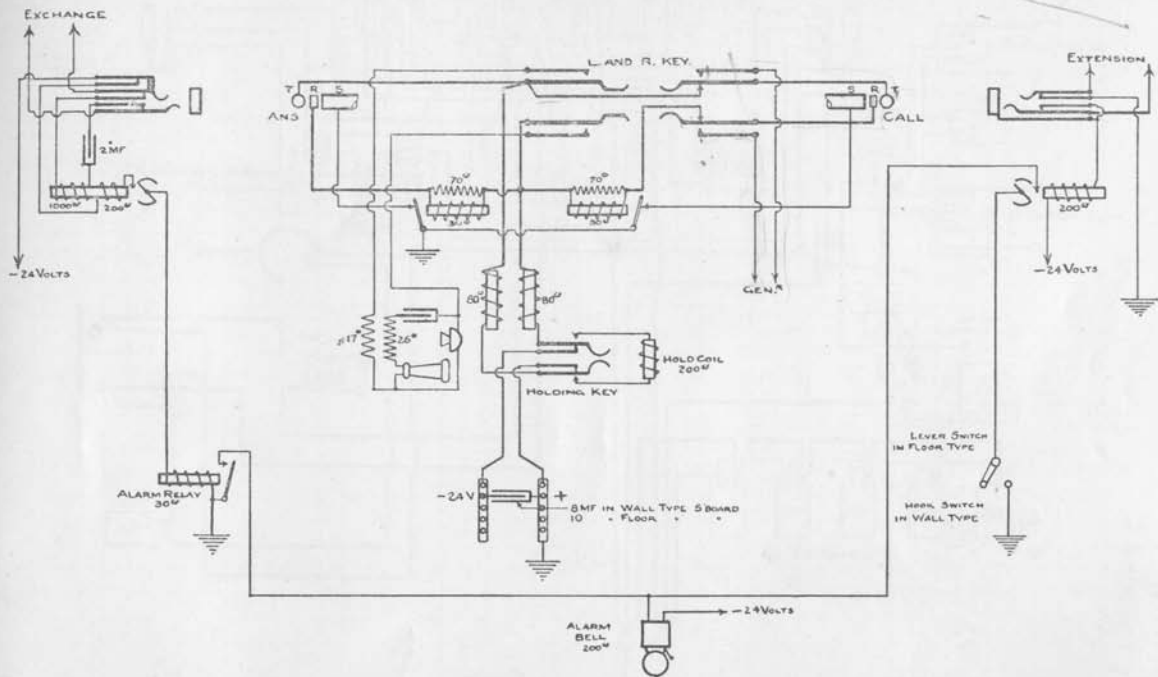

Diagram 62.

C-B P-B-X WITH PROP INDICATOR
W.E TYPE

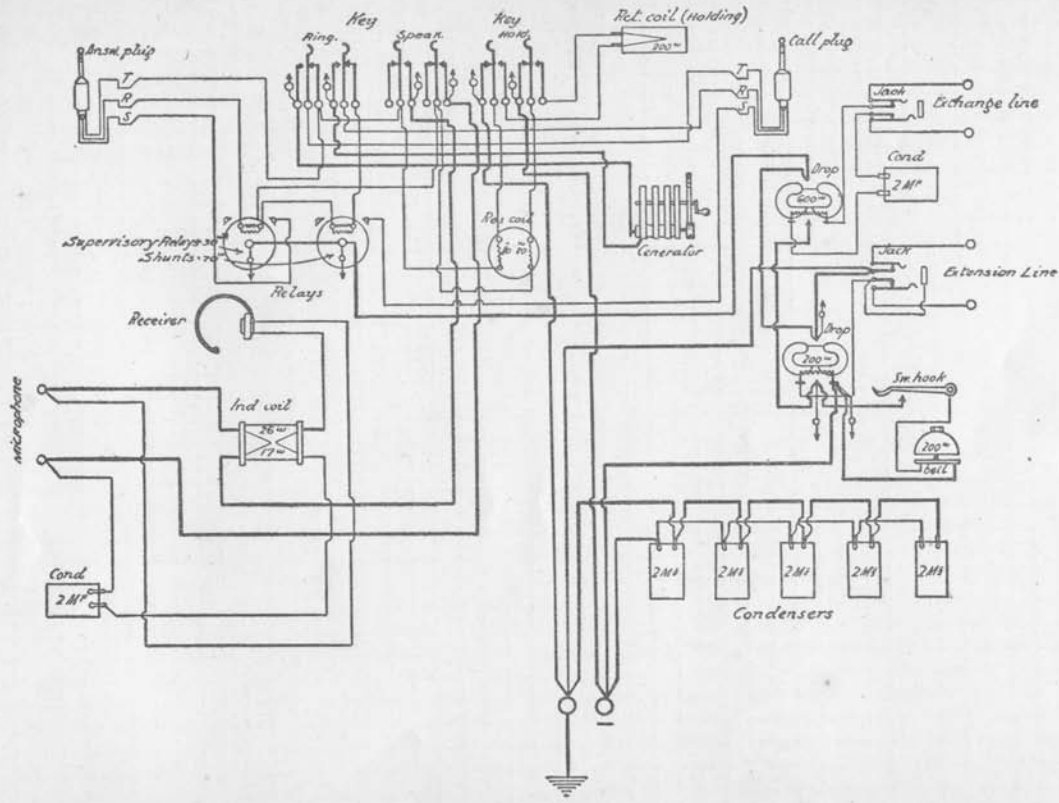

Diagram 63.

Part III.—Trunk Lines.

SECTION 1.

Magneto Trunk Line Circuits.

MAGNETO TRUNK LINE SYSTEMS

— FIG. 1 —
— Simple Magneto Trunk —

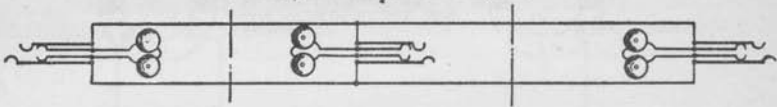

— FIG. 2 —
— Magneto Trunk with Telegraph Superimposed —

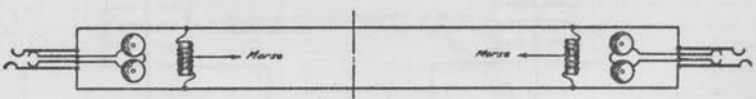

— FIG. 3 —
— Metallic Phantom on Two Magneto Trunks —

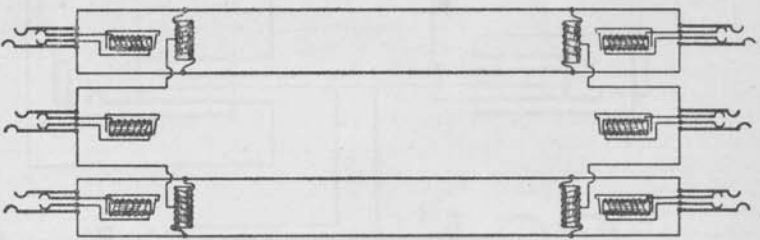

— FIG. 4 —
— Earth-Return Phantom on a Magneto Trunk —

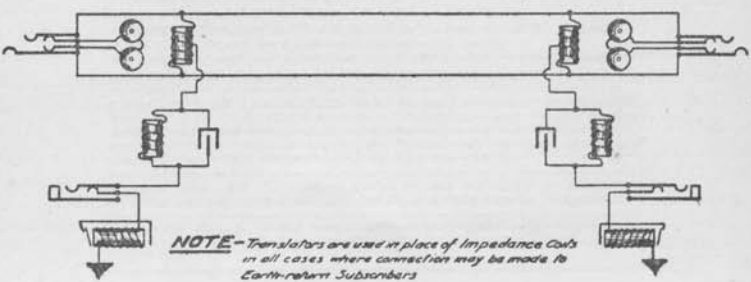

NOTE— Translators are used in place of impedance coils in all cases where connection may be made to Earth-return Subscribers

INTERMEDIATE TRUNK LINE STATION
CONNECTIONS

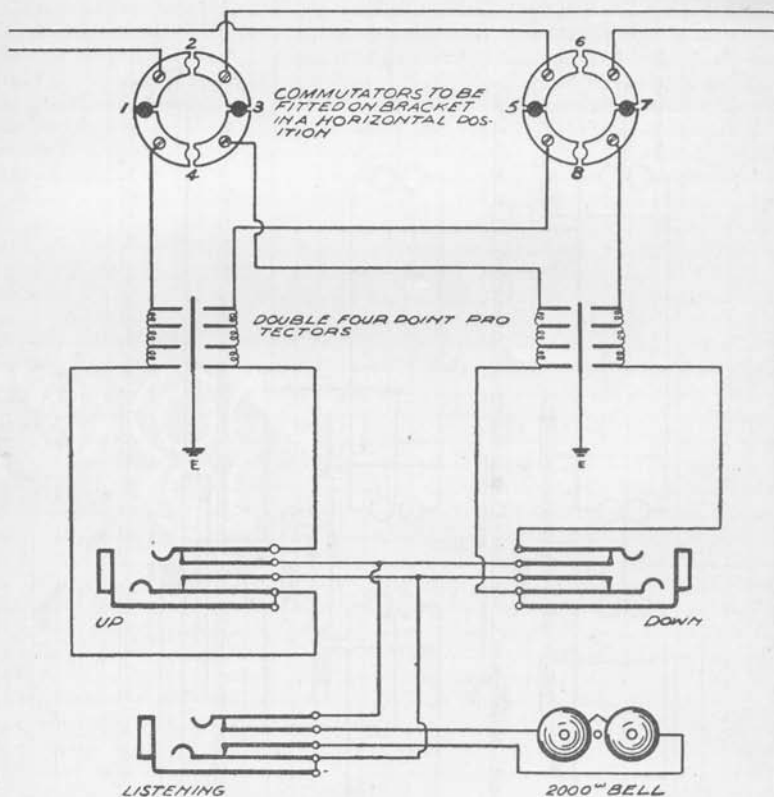

NOTES

TO JOIN LINES THROUGH CLEAR OF OFFICE, PLUG UP ONLY HOLES 2 AND 6 OF CIRCULAR COMMUTATORS. TO OPEN CIRCUIT EITHER SIDE OF LINE, INSERT BLACK EBONITE PLUG IN CORRESPONDING JACK. TO SHORT CIRCUIT EITHER SIDE OF LINE, INSERT SHORT CIRCUITING PLUG IN CORRESPONDING JACK.

CARE IS TO BE EXERCISED THAT PLUGS ARE NOT INADVERTENTLY LEFT IN JACKS WHEN NOT REQUIRED TO BE THERE, AND THAT THE UP AND DOWN JACKS ARE NEVER USED EXCEPT IT IS FIRST KNOWN (BY PLUGGING IN THE LISTENING JACK) THAT THE TRUNK LINE IS DISENGAGED.

A 2 MF ROLLED CONDENSER IS TO BE PLACED IN SERIES IN THE RECEIVER CIRCUIT OF THE OPERATING TELEPHONE

EBONITE PLUG TO BE PROVIDED FOR OPEN CIRCUITING, ALSO PLUG WITH TIP AND BODY CONNECTED FOR SHORT CIRCUITING

Diagram 65.

TRUNK LINE CIRCUITS VARIOUS

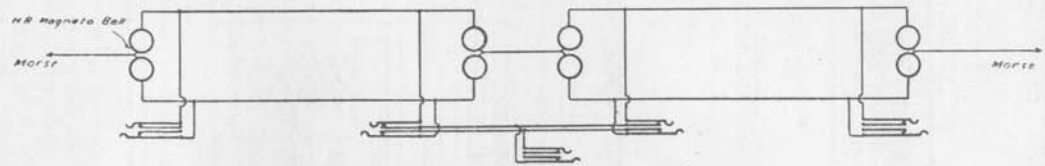

Trunk Line with Telegraph superimposed-Connections for dividing switches at intermediate station

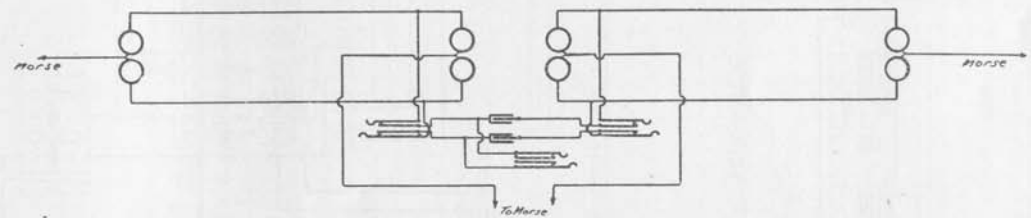

Trunk Line with Telegraph superimposed-Connections for dividing switches at intermediate Stn where Morse installed



Method of connecting single [earthed circuit] Line to Metallic Line by means of Transformer

TRUNK LINE WITH MORSE SUPERIMPOSED
 TERMINAL STATION CONNECTIONS.

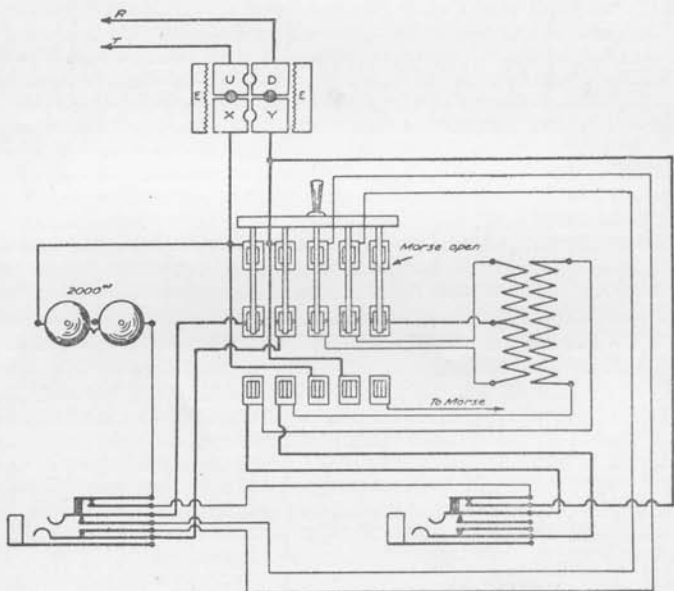

KNIFE SWITCH IN POSITION, METALLIC CIRCUIT, MORSE OPEN.

— SCHEMATIC CONNECTIONS —

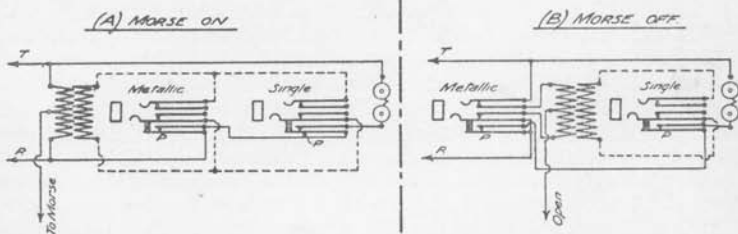

NOTE:— When a Plug is inserted in each of the Jacks, Contacts 'P' open.

SECTION 2.

Condenser Trunk Line Circuits.

SYDNEY MELBOURNE TRUNK AT MELBOURNE

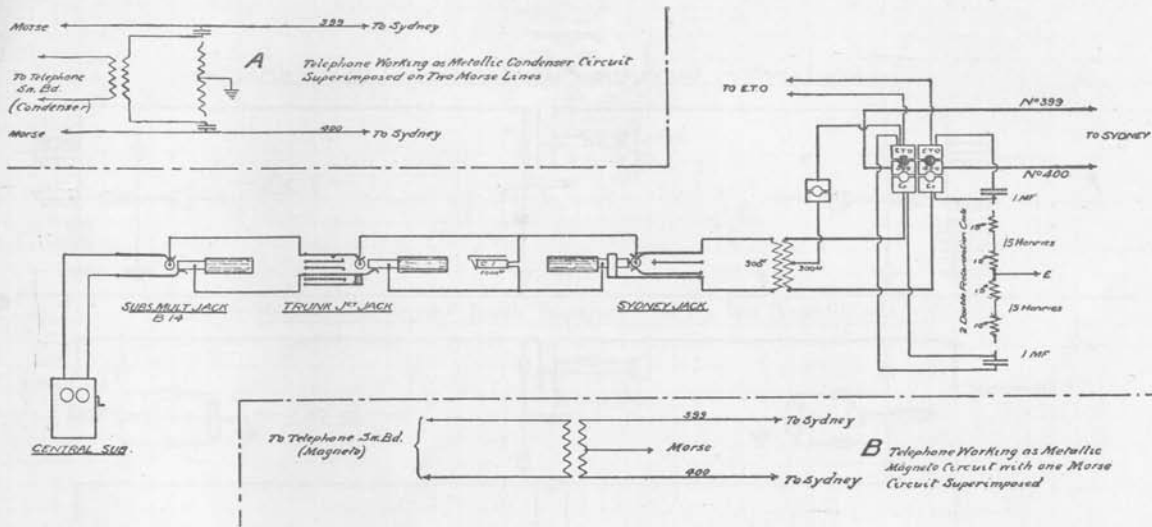

CONDENSER TRUNK LINE SYSTEMS

— Earth-Return Condenser Trunk Superimposed on Morse Circuit —

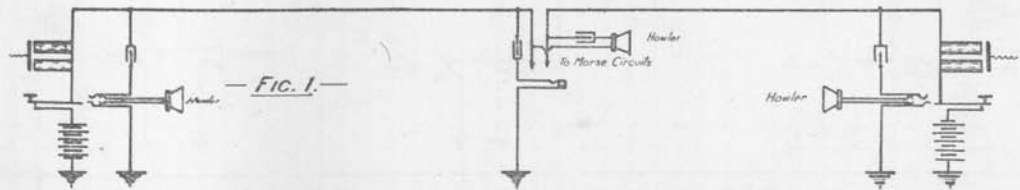

— Metallic Condenser Trunk Superimposed on Two Morse Circuits —

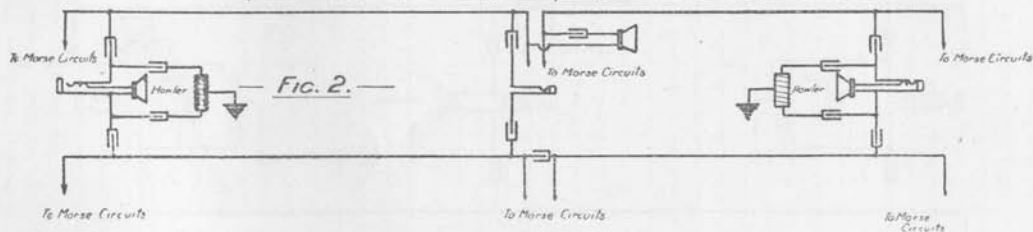

CONDENSER TRUNK LINE SYSTEM S.A

Earth-Return Condenser Trunk Superimposed on Morse Circuit.

FIG. 1.

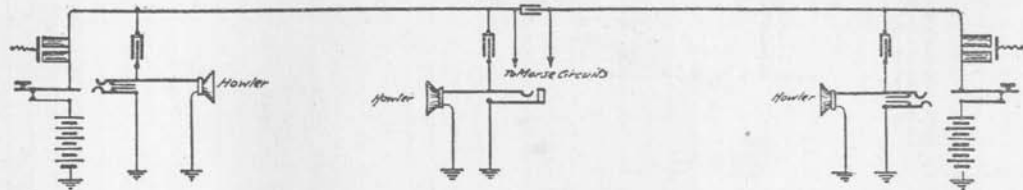

Metallic Condenser Trunk Superimposed on Two Morse Circuits.

FIG. 2.

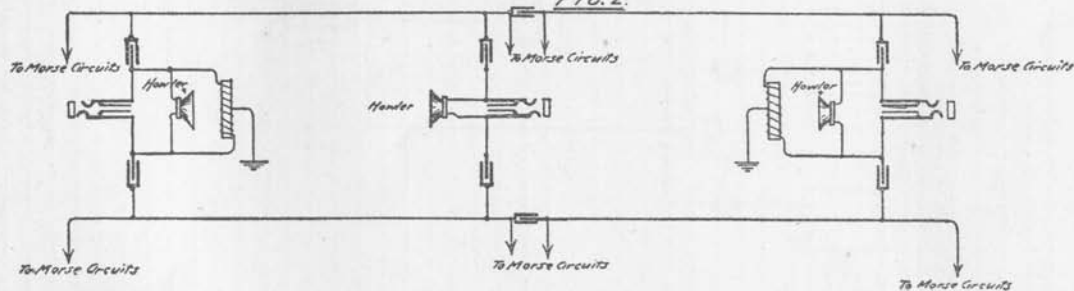

CONDENSER TELEPHONE STATION
 SINGLE LINE, INTERMEDIATE,
 WITHOUT MORSE

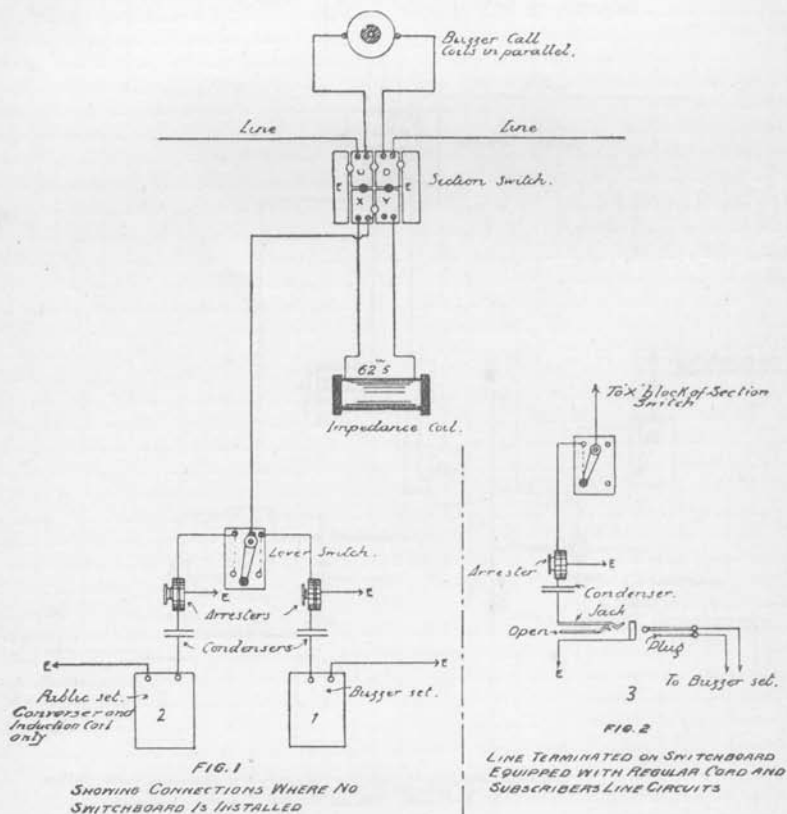
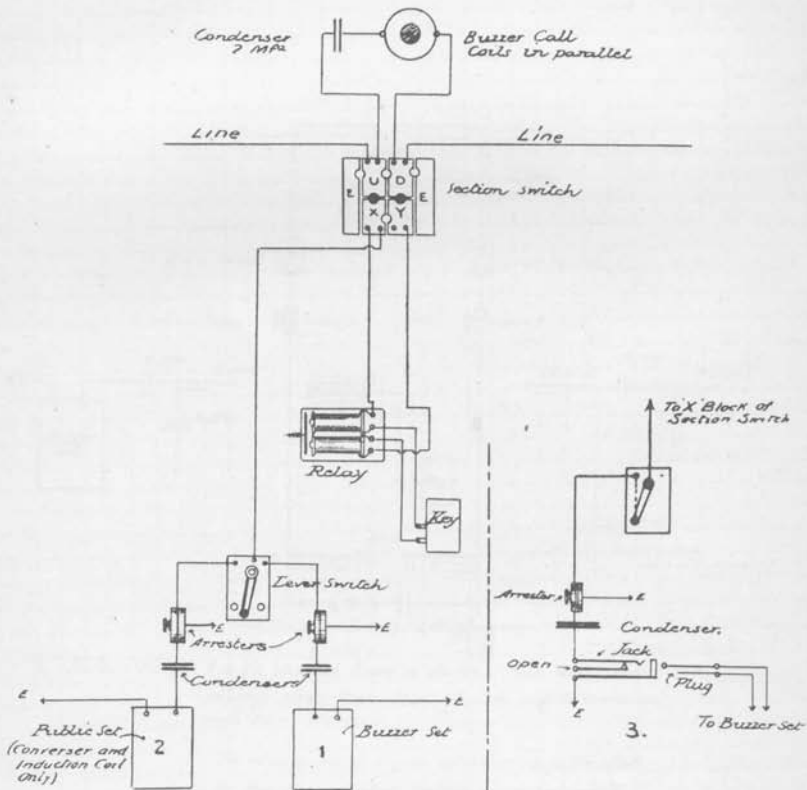

Diagram 71.

CONDENSE TELEPHONE STATION
SINGLE LINE INTERMEDIATE



NOTE: Where capacities of Condensers are not shown, the capacities are determined by calling what is required for any effective service Min^m 1/4 MF. Max^m 1 MF

FIG. 1

Showing Connections Where no Switchboard is Installed.

FIG. 2

Line Terminated on Switchboard Equipped with Regular Cord and Subscribers Line Circuits

CONDENSER TELEPHONE STATION
 SINGLE LINE, INTERMEDIATE EQUIPPED FOR
 DIVIDING THE TELEPHONE CIRCUIT

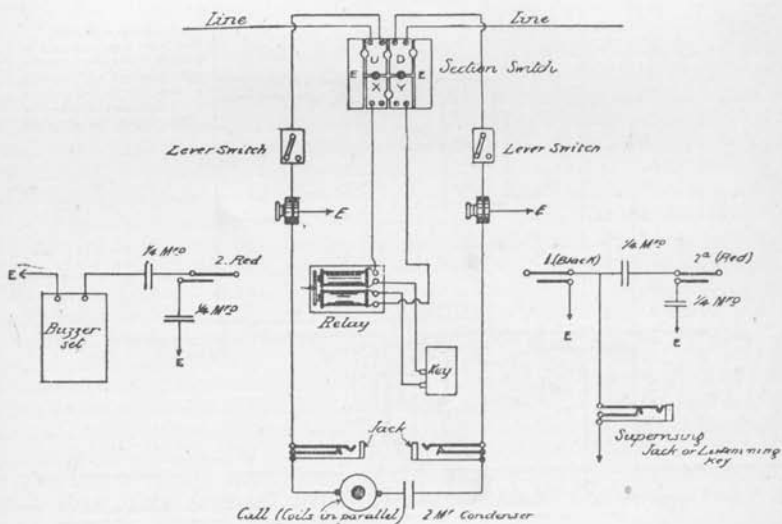

Note:- Plugs 2 & 2a should have a distinct and different colored cover from that of plug 1. This provision will save confusion

The arrangement shown above is suitable also for Non-Morse Station bridging condenser not required

Diagram 73.

CONDENSER TELEPHONE STATION
METALIC LINE INTERMEDIATE

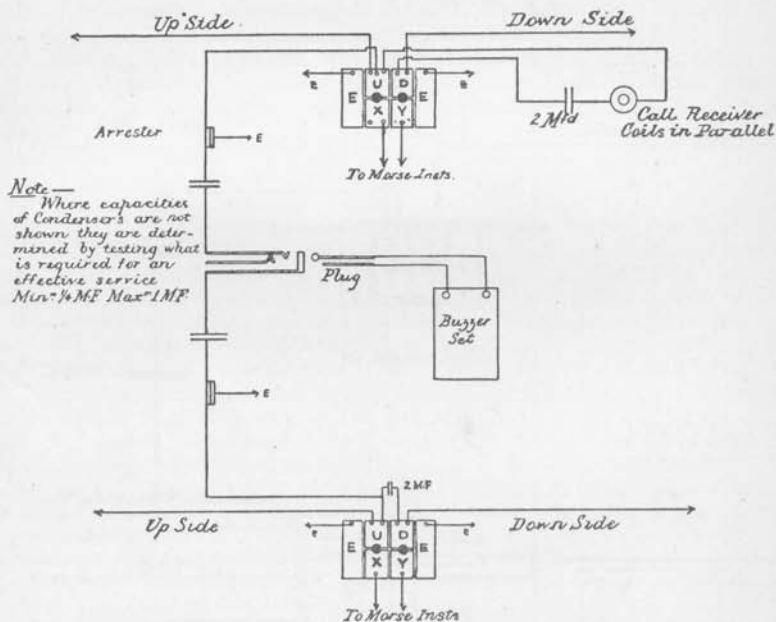

— One Side looped and the other teed in —

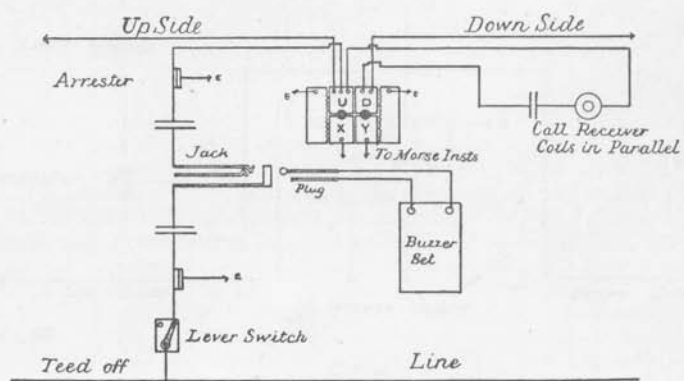

Diagram 74.

CONDENSER TELEPHONE STATION METALLIC LINE TERMINAL

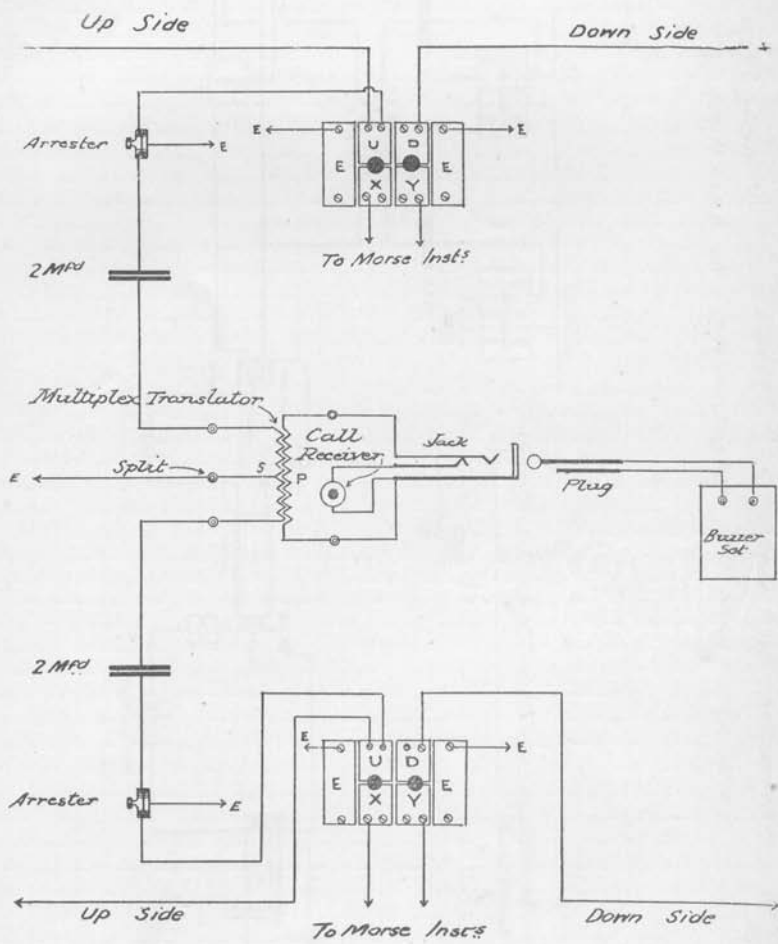

Diagram 75.

CONDENSER TELEPHONE STATION METALLIC LINE
 TERMINATED ON SWITCHBOARD FOR NIGHT SERVICE

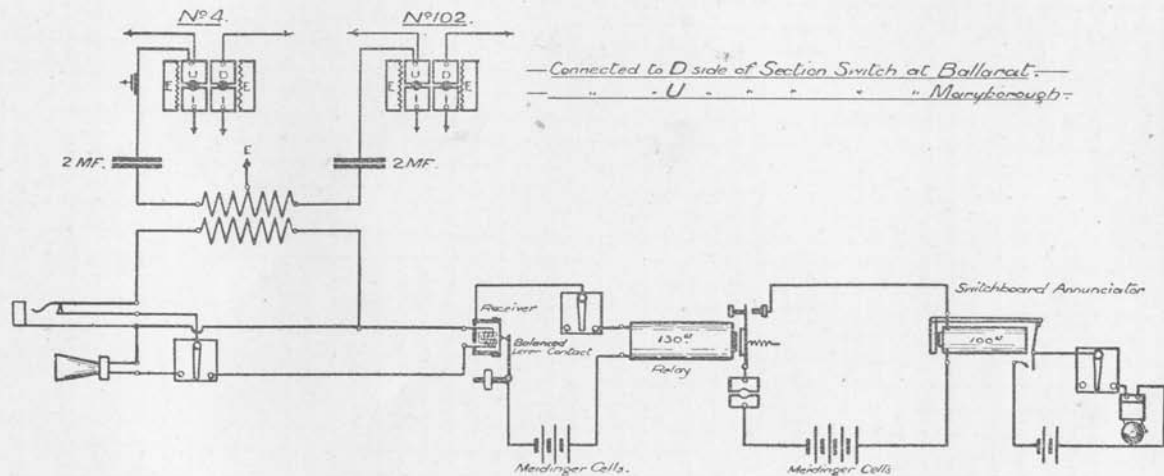

Diagram 76.

Part IV.—Miscellaneous.

SECTION 1.

Telephone Circuits.

IMPROVED CONNECTIONS FOR MAGNETO TELS
WORKING ON CB SYSTEMS.

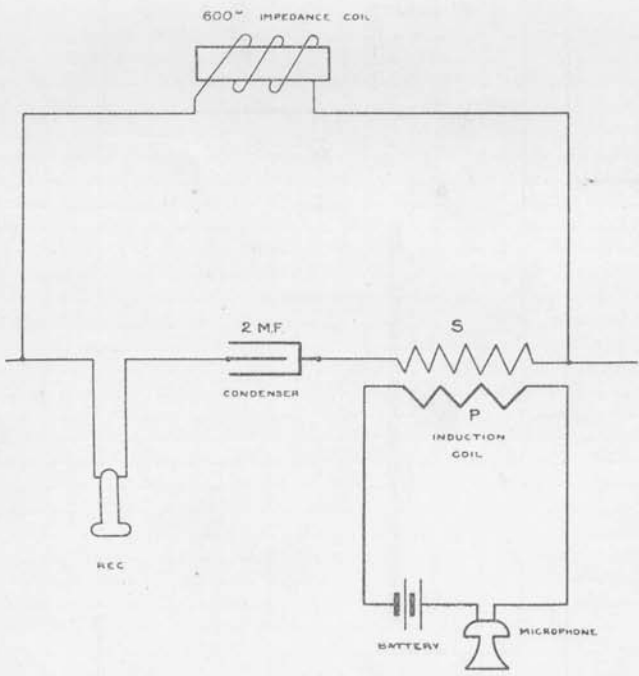

Diagram 77.

TELEPHONE C.B. MAIN & AUXILIARY, TO RECEIVE calls on Auxiliary set No intercommunication.

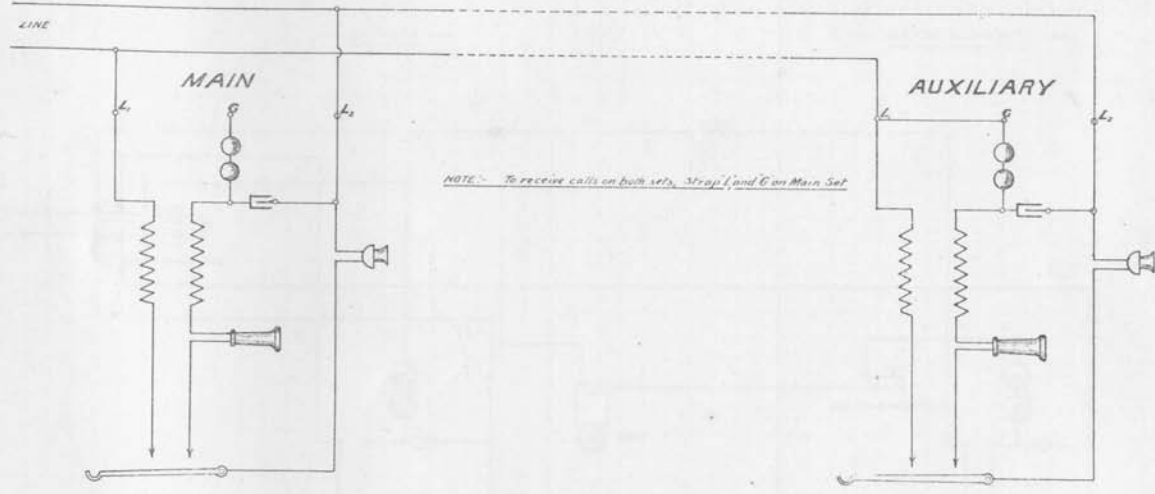

Diagram 78.

— SIMPLE EXTENSION CIRCUIT WITH SECRECY SWITCH AT MAIN —
CALLS NORMALLY RECEIVED ON AUXILIARY SET —
— PRESS BUTTON AND BELL FOR CALLING MAIN FROM AUXILIARY WHEN REQUIRED —

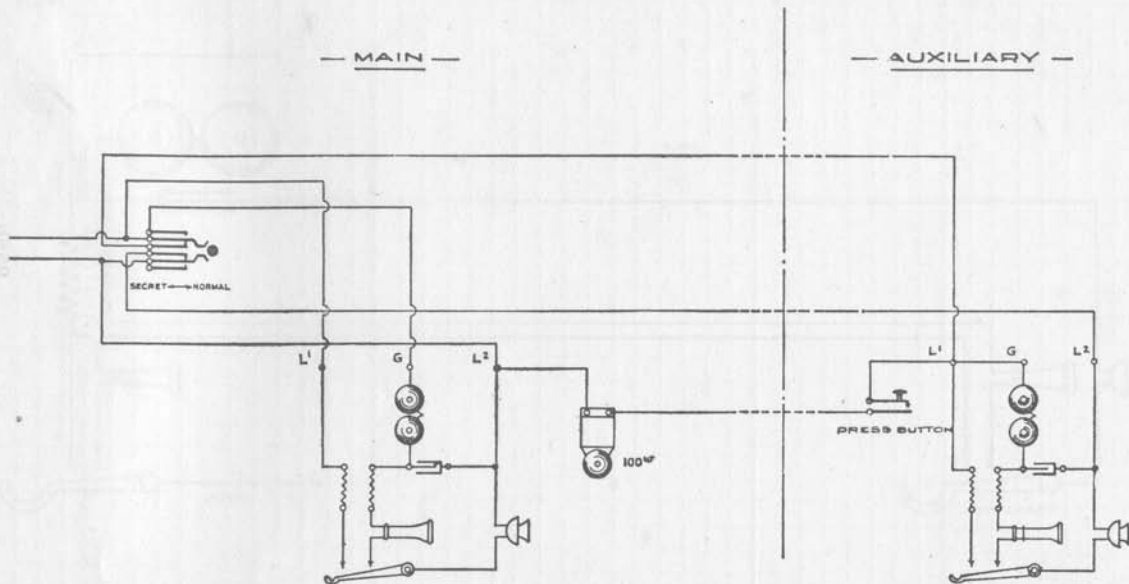

Diagram 78a.

TELEPHONE C.B. MAIN & AUXILIARY, using one coil and Condenser no intercommunication.

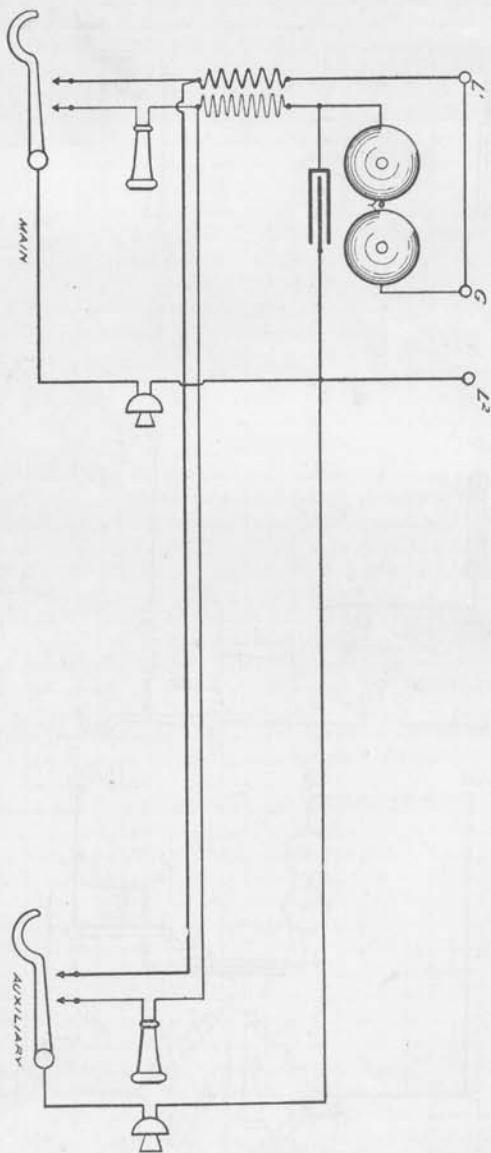
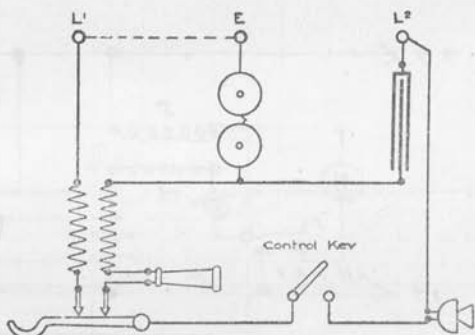

Diagram 79.

TELEPHONES C.B. WITH CONTROL KEYS.

W.E.



C.E.

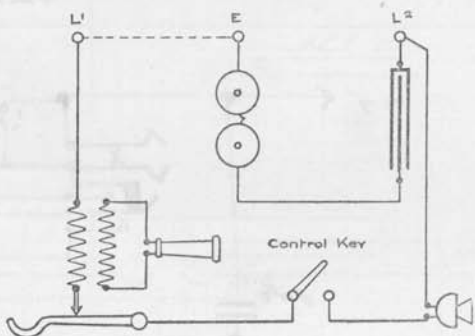

B.I.

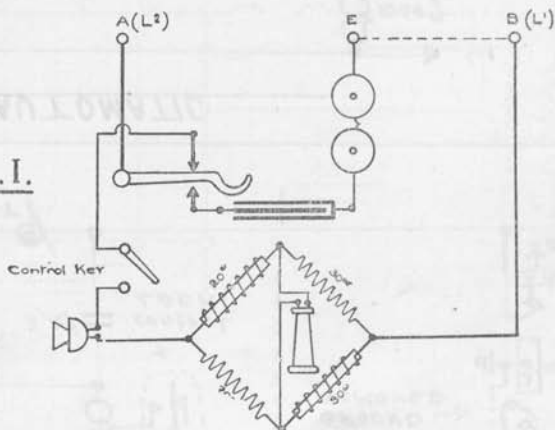

Diagram 80.

CONTROL LOCKS.

C.B. MANUAL

SUB STATION.

EXCHANGE.

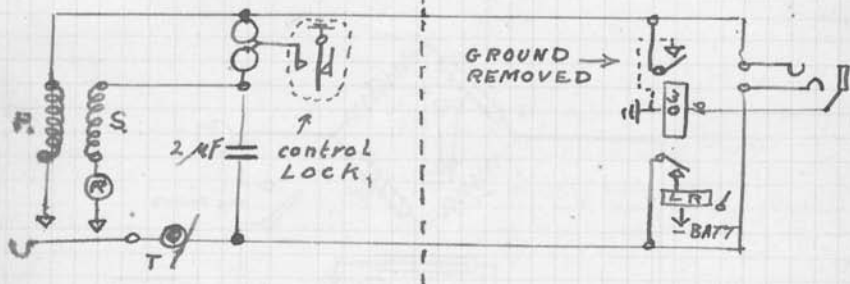

AUTOMATIC

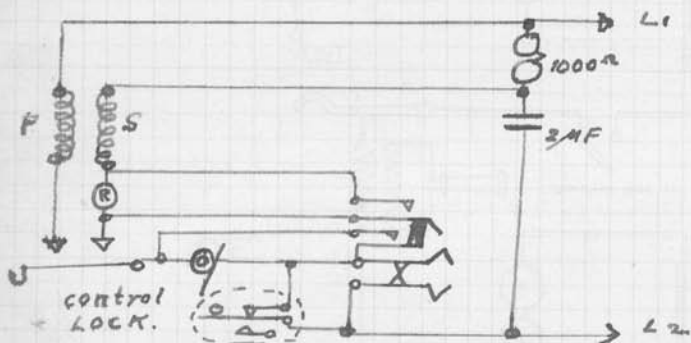

MAGNETO.

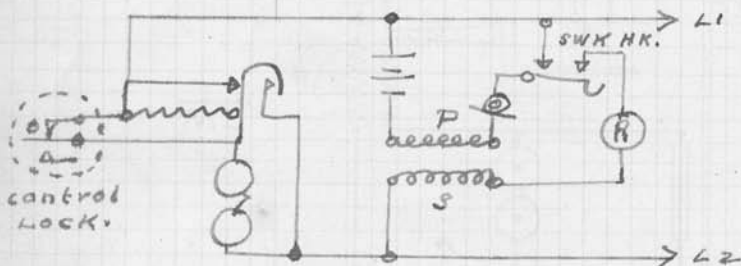

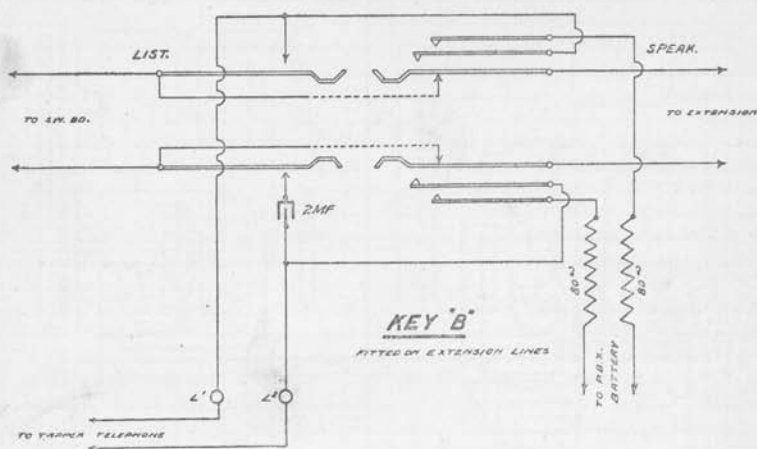
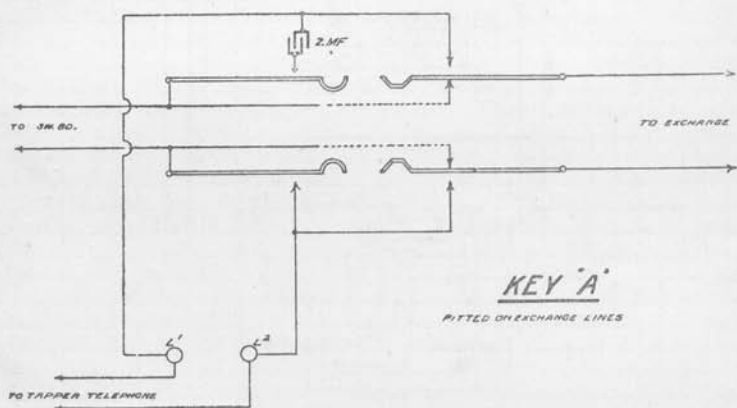
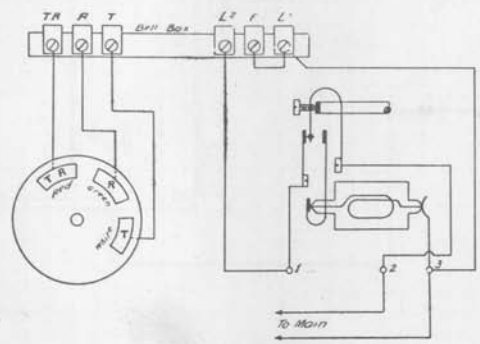
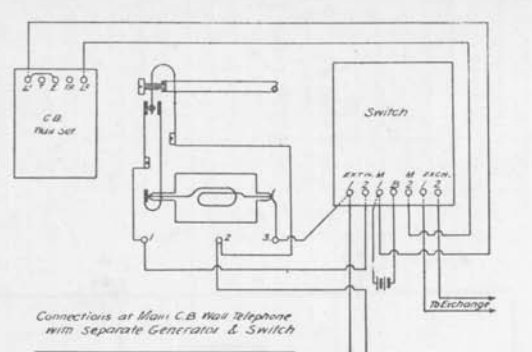

Diagram 81.



Connections at Extension
 C.B. Table Telephone with Separate Generator



Connections at Main C.B. Wall Telephone
 with Separate Generator & Switch

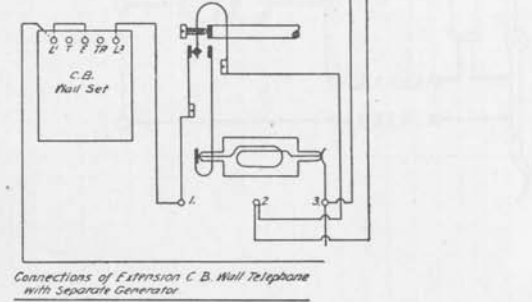

Connections of Extension C.B. Wall Telephone
 with Separate Generator

TELEPHONE C.B. METHOD of Connecting
Ericsson Party Line Register 60.

502

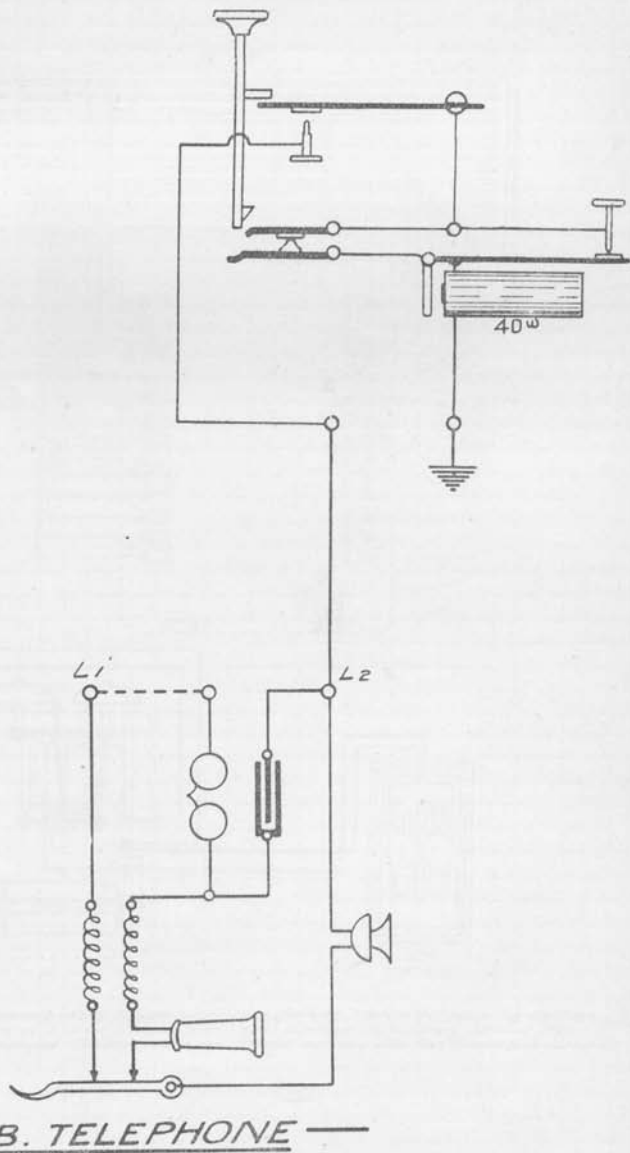

Diagram 83.

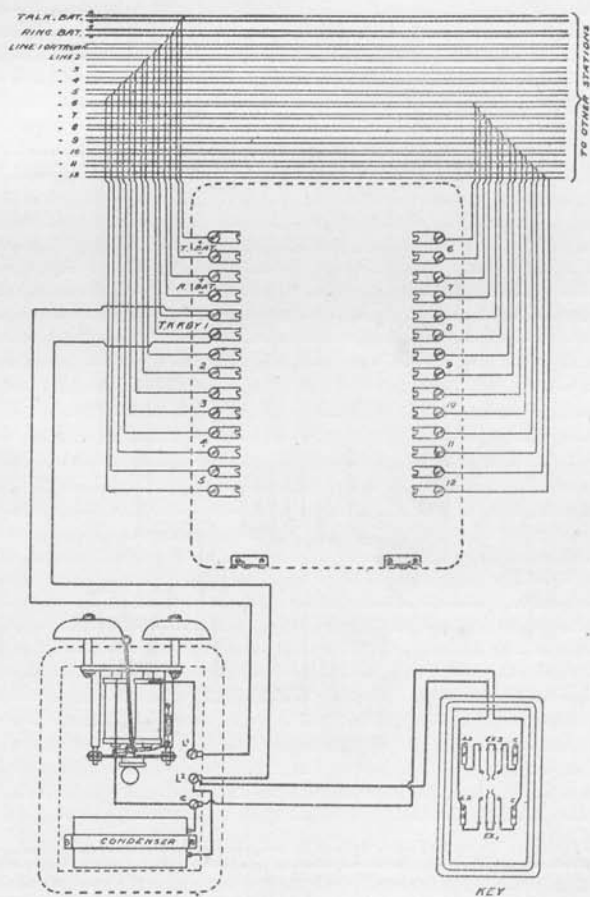

Diagram showing connections of Apparatus at Transferring Station for securing Central Battery Exchange Service in conjunction with Local Intercommunicating Service, Wall Telephone being employed. Connections show Eleven Stations and One Trunk Line wired in.

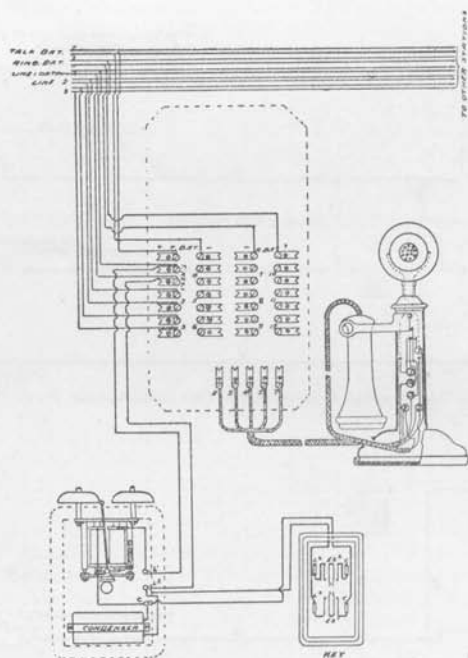
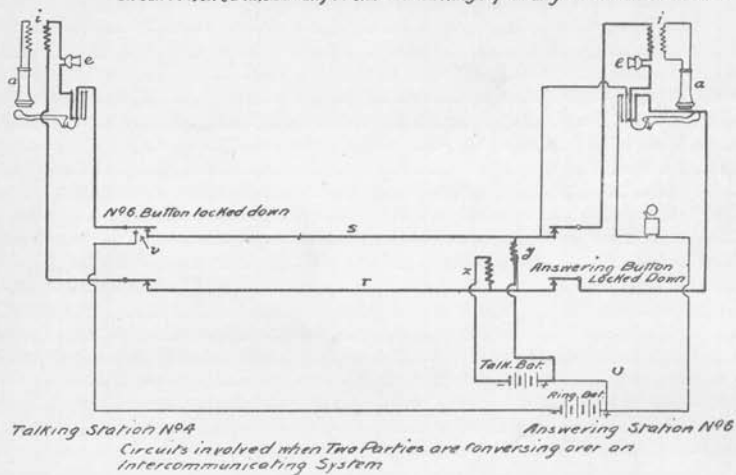
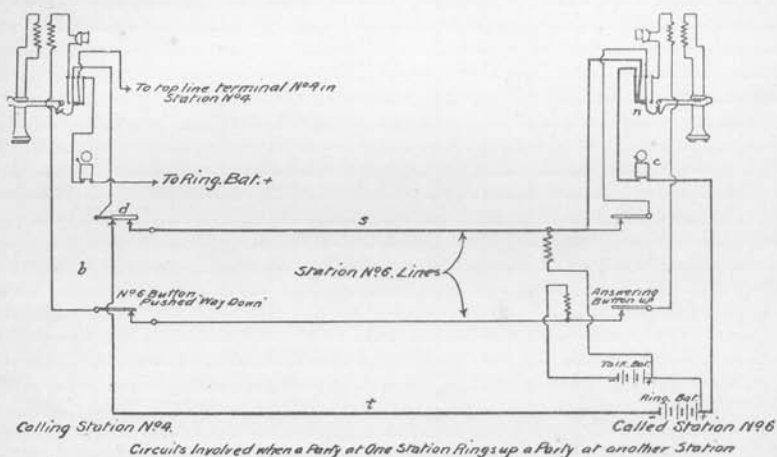

Diagram showing connections of Apparatus at Transferring Station for securing Central Battery Exchange Service in conjunction with Local Intercommunicating Service, Desk Telephone being employed. Connections show Two Local Lines and One Trunk wired in. The Other Local Lines may be reconnected in same Manner as Line 2 or Line 3.

INTERCOMMUNICATING SYSTEM C.B. W.E. No. 2.
TELEPHONE CIRCUITS [SCHEMATIC.]



SECTION 2.

Switchboard Circuits.

ELECTRICAL ENGINEER'S BRANCH,
GENERAL POST OFFICE,
MELBOURNE.

MAGNETO SWITCHBOARD. P.B.X Fitted with
Condensers for C.B. Service.

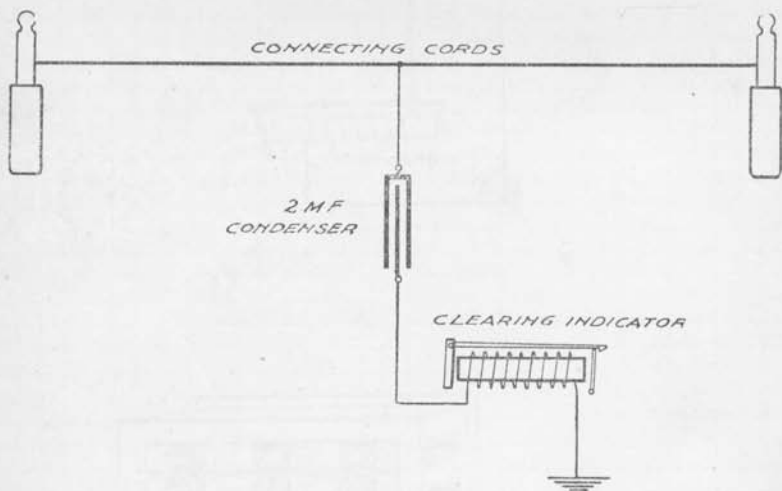
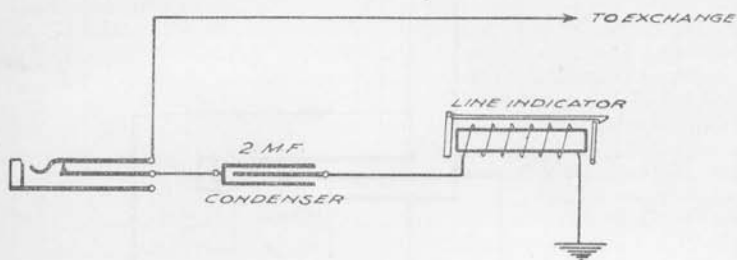

MAGNETO SWITCHBOARD. P.B.X Fitted with Holding Coil for G.B. Service.

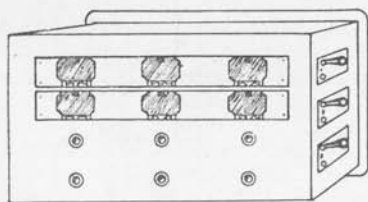
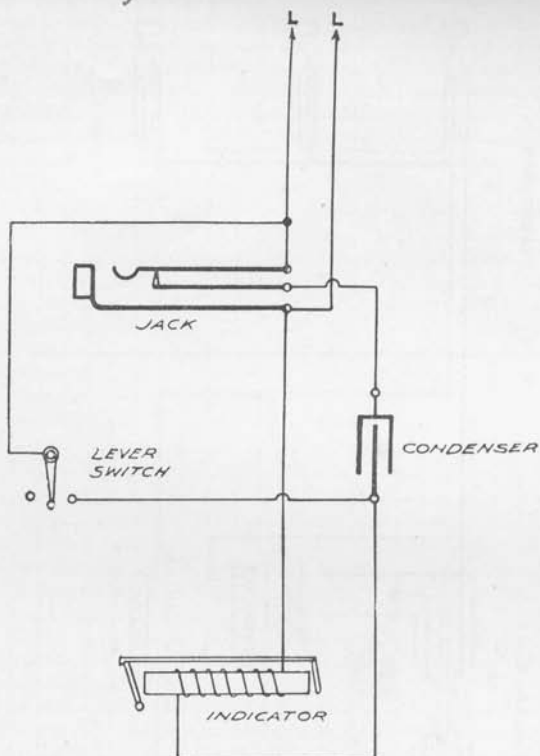

Magneto Switchboards. Earthed circuit
Transfer Circuit (one way) for.

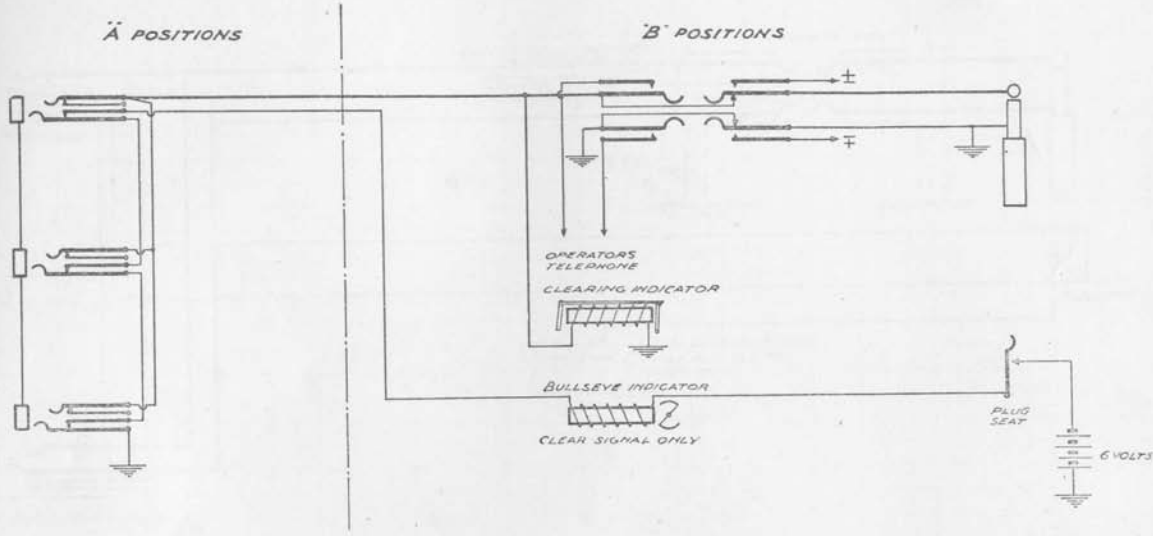

Diagram 89.

MAGNETO SWITCH BOARDS. METALLIC CIRCUIT
TRANSFER CIRCUIT (ONEWAY) for

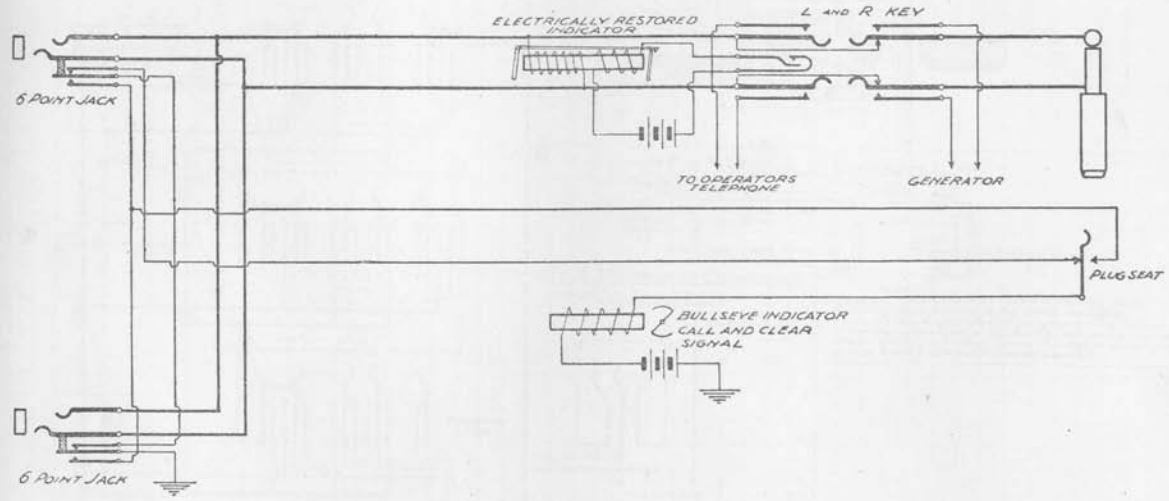

Diagram 90.

SWITCHBOARD C.B. Cordless adapted for working on Automatic Systems. P.B.X.

FIG 1 DIAGRAM OF CONNECTIONS
ARRANGEMENT TO DISCONNECT EXCHANGE LINE INDICATOR
WHEN LINE IN USE.

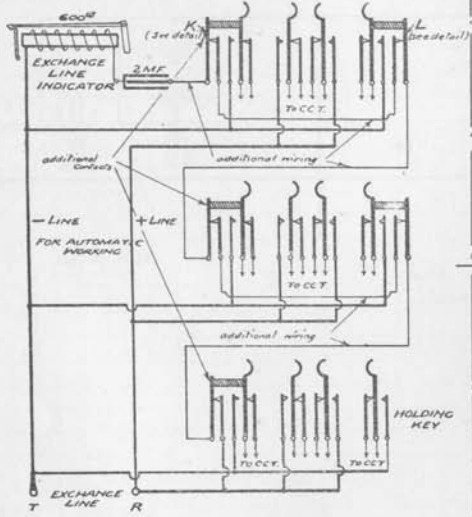

FIG 2 SIDE ELEVATION OF KEY

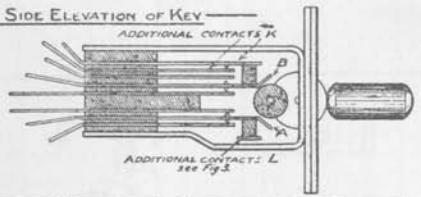

FIG 3 DETAILS OF CONTACTS L

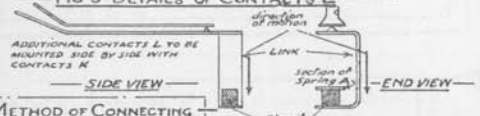
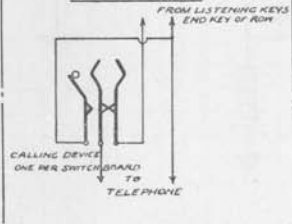
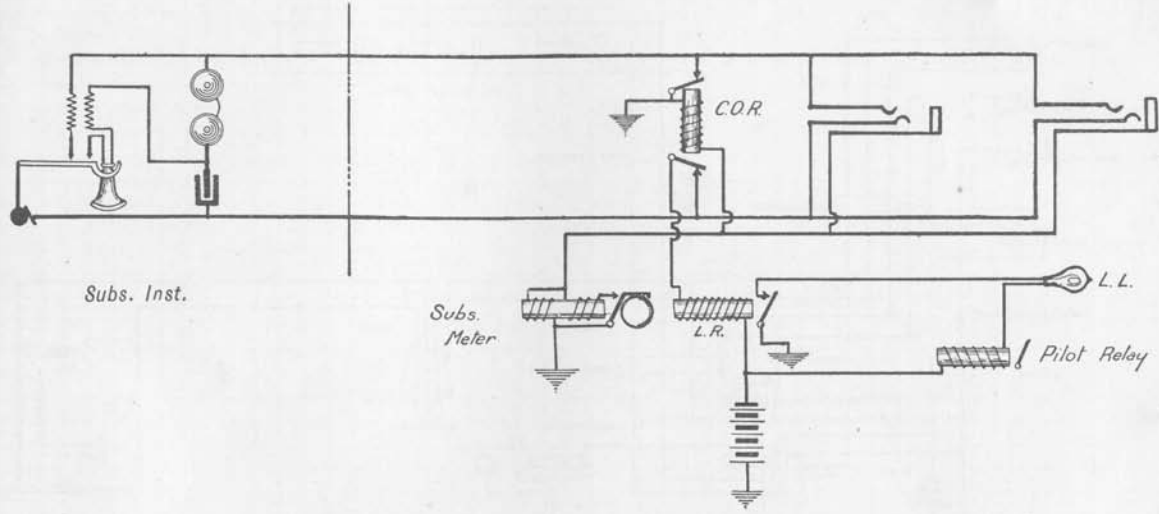

FIG 4 METHOD OF CONNECTING
CALLING DEVICE



NOTE: - Contacts K & L on each Key are to be mounted side by side in the space available. Contacts K are operated directly by spring B when it is moved upward, while contacts L are actuated by means of the Link when Spring A is moved downward. Contacts K & L are both break contacts.

SWITCHBOARD C.B. (W.E. No 1).
SUBSCRIBERS LINE CIRCUIT.



SWITCHBOARD C.B. BI CO.
SUBSCRIBERS LINE CIRCUIT.

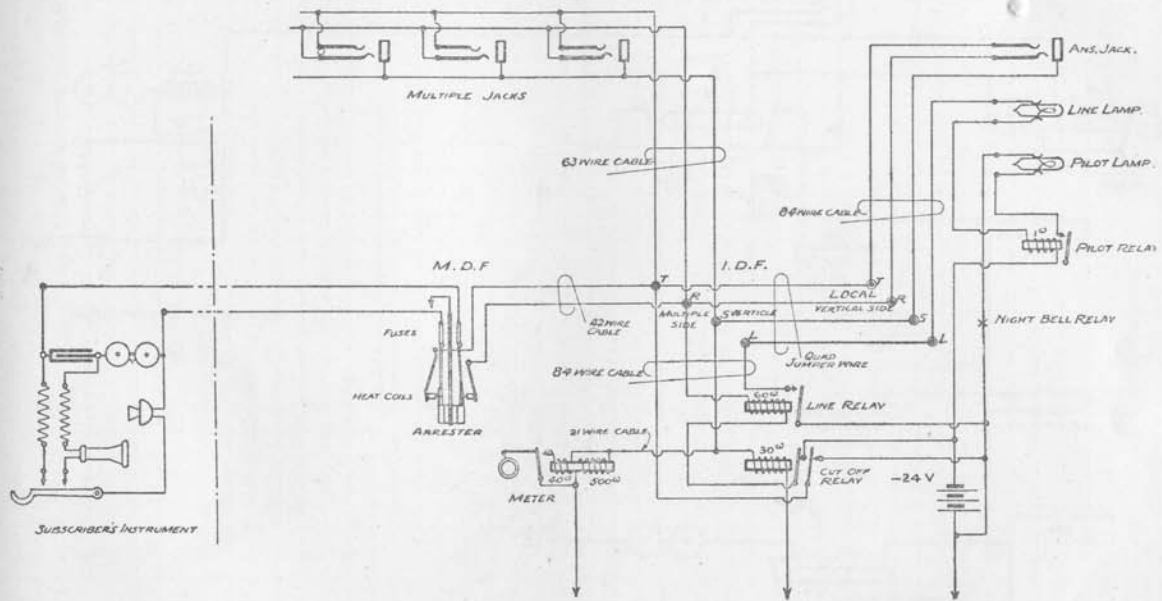

Diagram 93.

SWITCHBOARD C.B. G.E. Coy.
 SUBSCRIBERS LINE CIRCUIT.

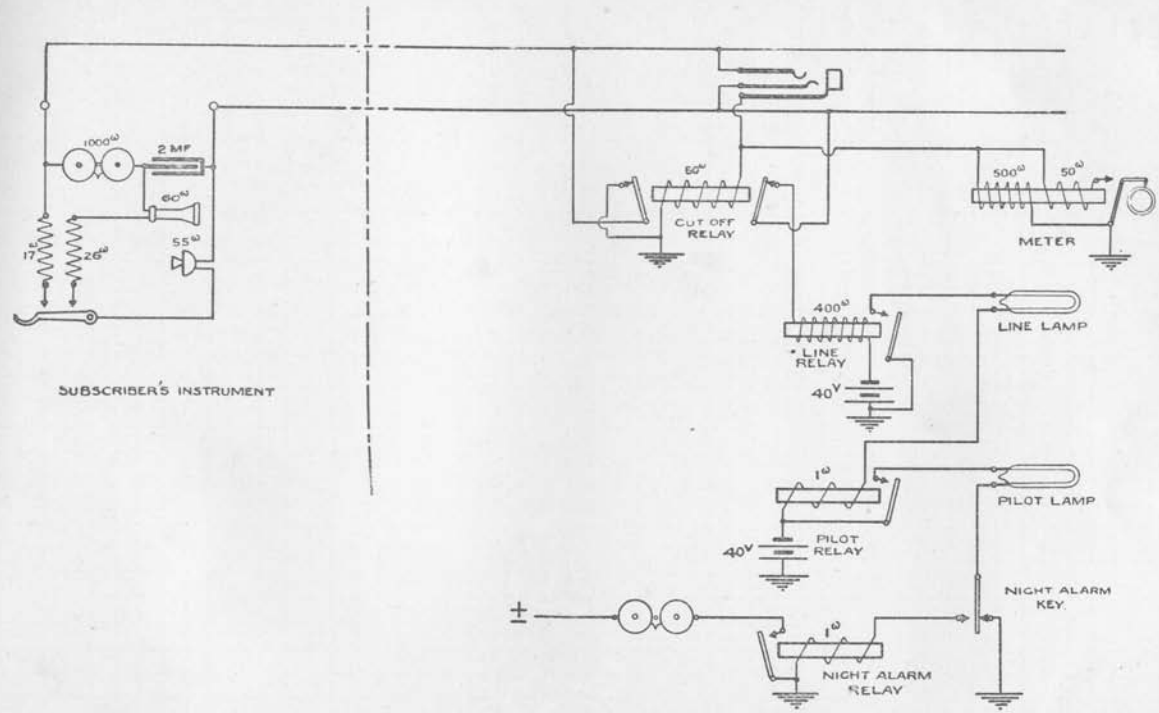

Diagram 94.

SECTION 3.
Apparatus—Various.

BUSY BACK, BATTERY OPERATED.

WIRING & SCHEMATIC CIRCUIT.

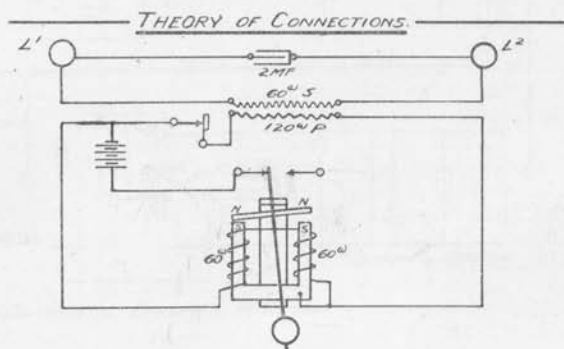
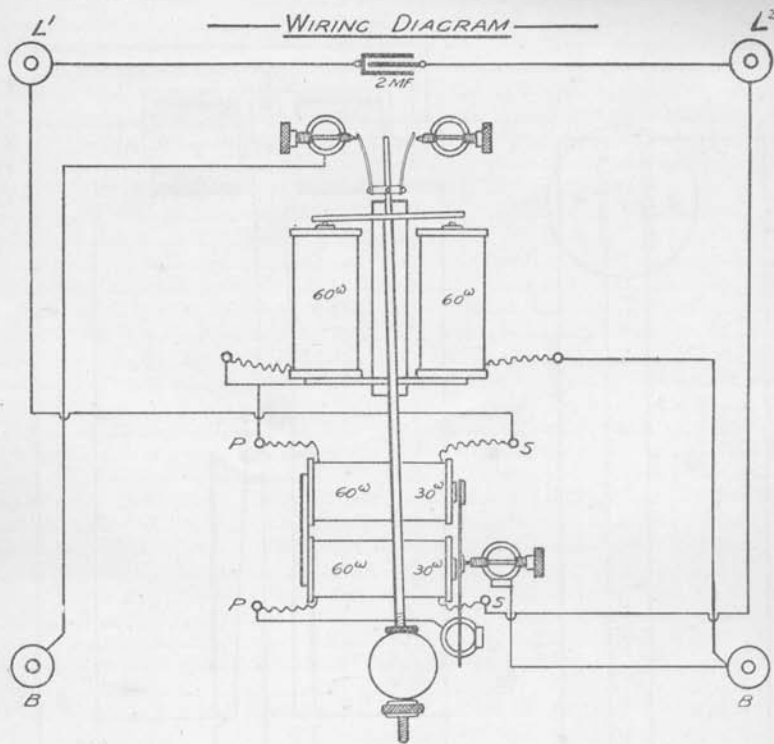
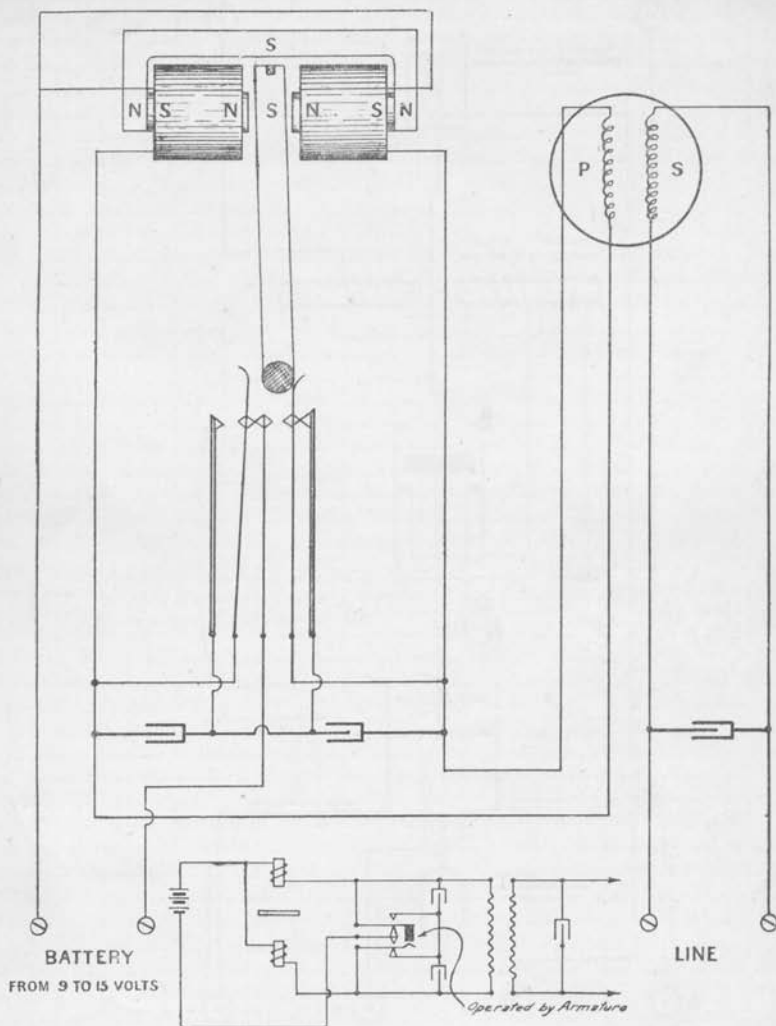

Diagram 95.



Schematic Diagram of Circuit

POLEchanger BATTERY (old Form.)

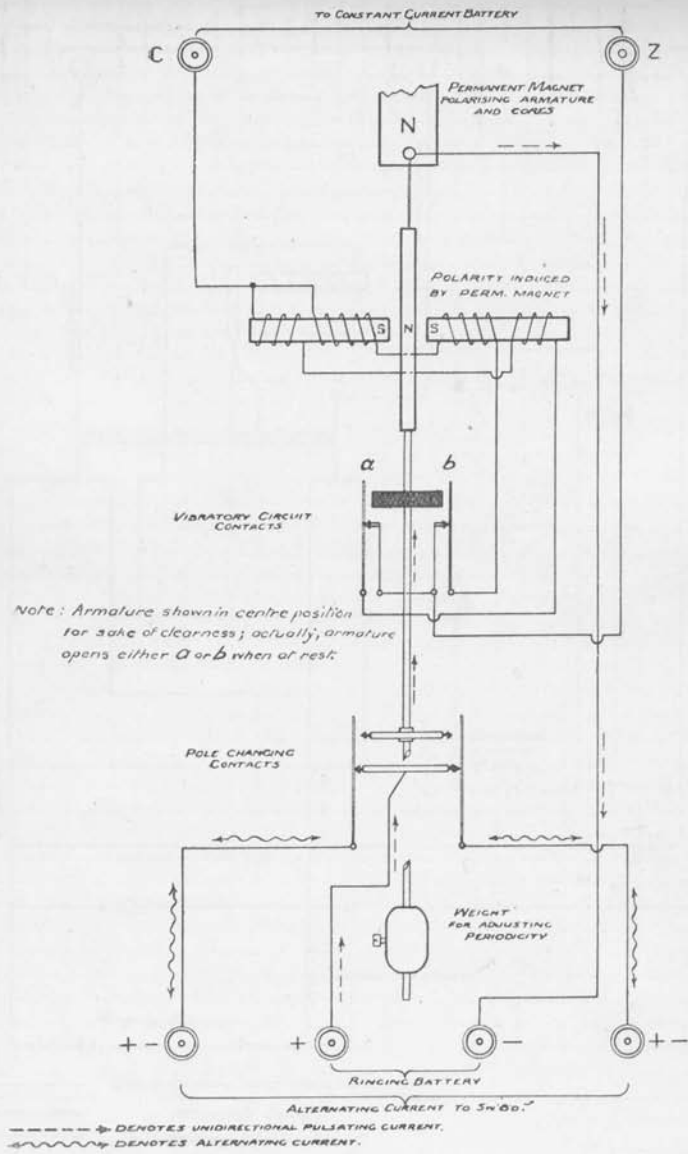
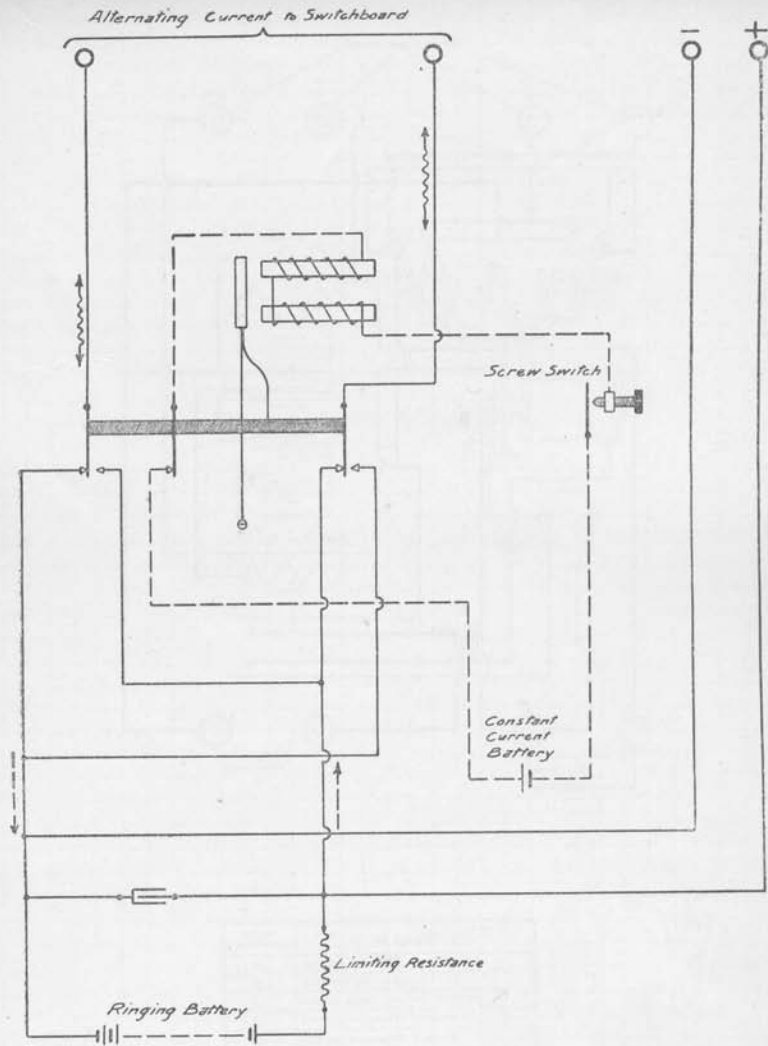

Diagram 97.

POLECHANGER Sandwich Type.



- > Denotes Unidirectional Pulsating Current
- - - - -> • Alternating Current
- - - - -> • Primary Vibratory Circuit

Diagram 98.

POLECHANGER, BATTERY, WARNER TYPE.

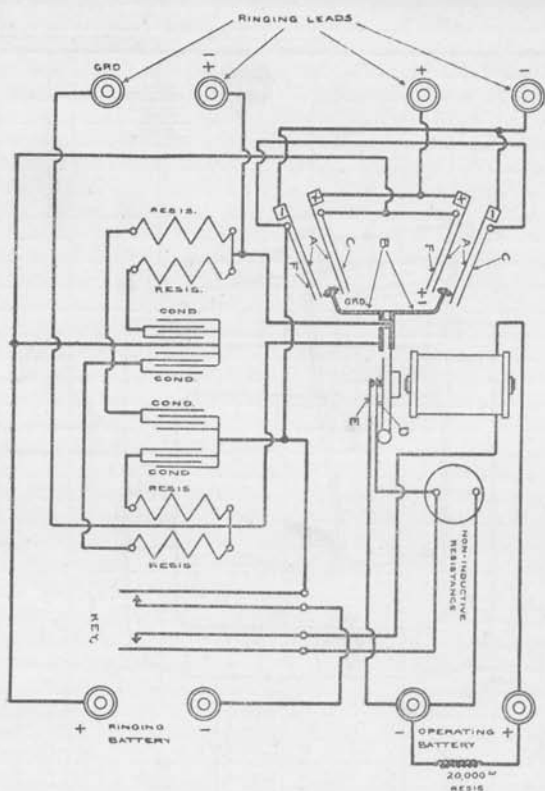

REF. LETTER	NAME
A	UPPER RINGING SPRING
B	VIBRATOR ARM
C	OUTER BACK RINGING SPRING
D	INNER MAGNET SPRING
E	OUTER MAGNET SPRING
F	OUTER FRONT RINGING SPRING

SCHEMATIC CIRCUIT.

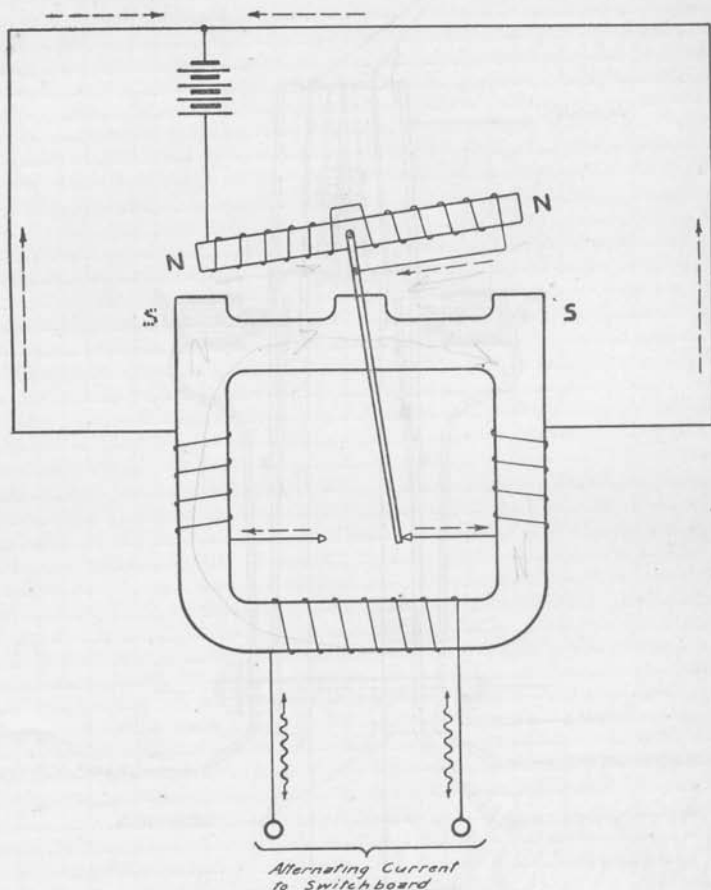

Alternating Current
to Switchboard

-----> Denotes Unidirectional Pulsating Current

~> • Alternating Current.

Diagram 100.

PROTECTORS M.D.F. W.E. TYPE.

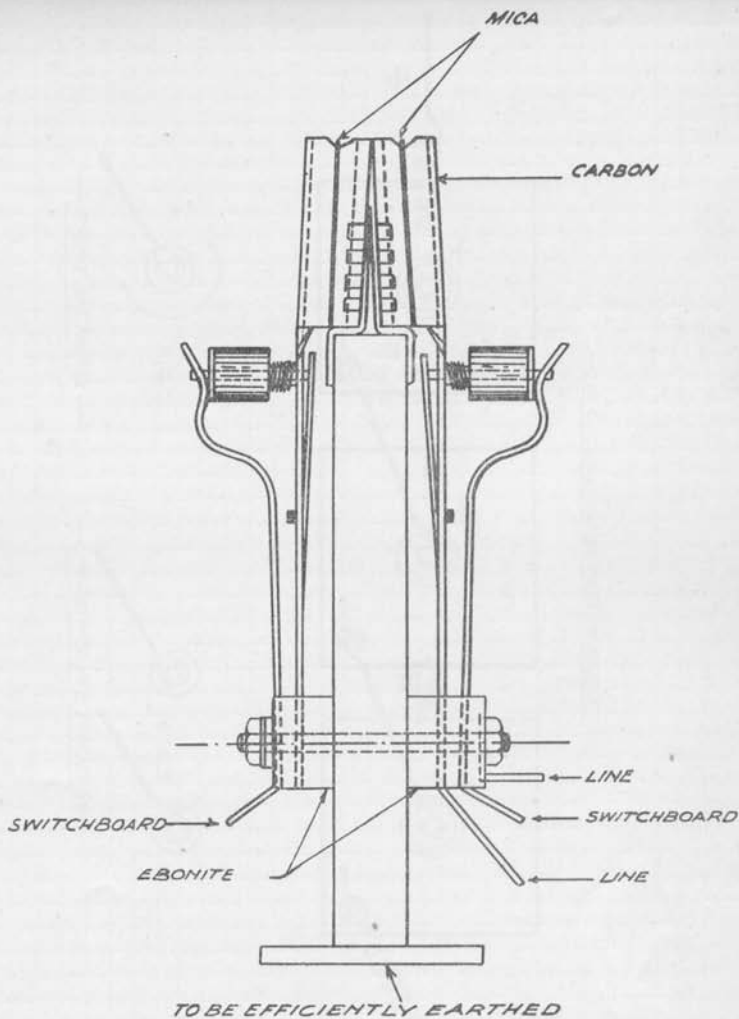

NOTE:-

WHEN FUSES ARE PROVIDED THE
LINE IS FITTED DIRECT TO FUSE
THEN TO ARRESTER

Diagram 101.

— 3 CELLS CONNECTED IN SERIES —

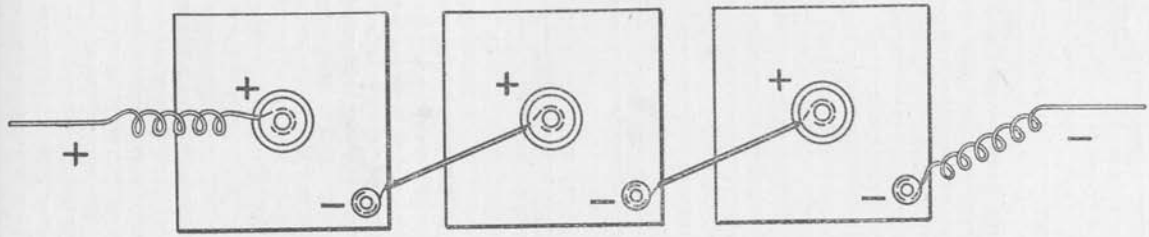
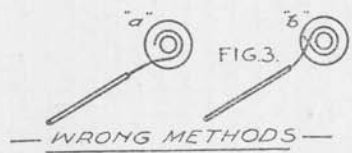

FIG. 1.



SECTION 4.

Conventional Signs, &c.

CONVENTIONAL SIGNS TO BE USED ON DIAGRAMS

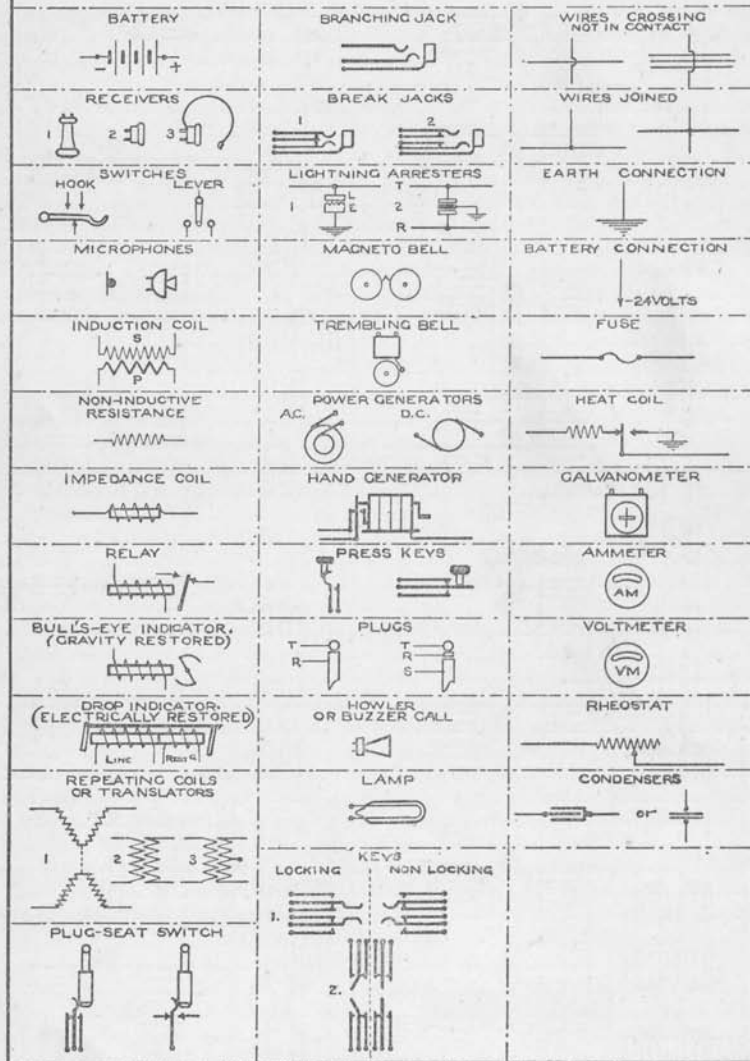

TYPES OF UNION KEYS.

— THE NUMBERS SHOW THE CORRESPONDING SPRINGS IN THE TWO CASES —

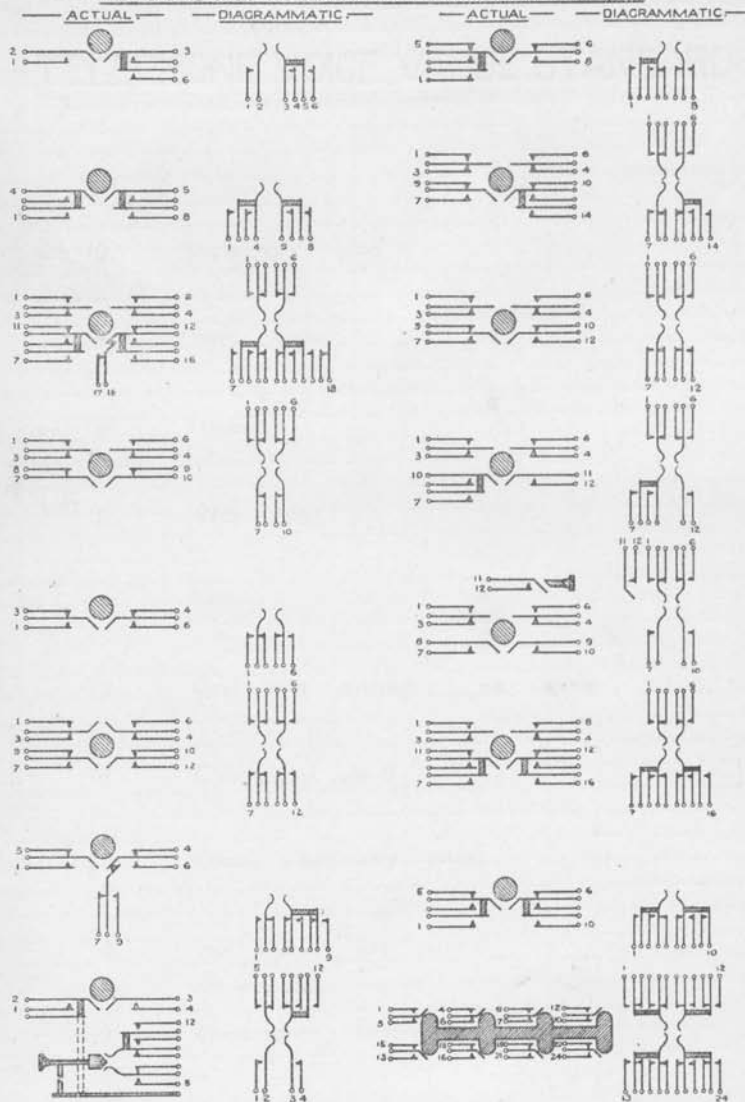

Diagram 104.

—TELEPHONE VOICE VALUE STANDARD—

10	Exceedingly good
9	Very good
8	Good
7	Very fair
6	Fair
5	Clear and distinct ; no volume
4	Clear , but faint
3	Clear, but very faint
2	Not clear , very faint
1	Conversation impossible

Part V.

**TESTING APPARATUS AND ELECTRICAL
MEASUREMENTS.**

STANDARD TRANSMISSION CIRCUIT.

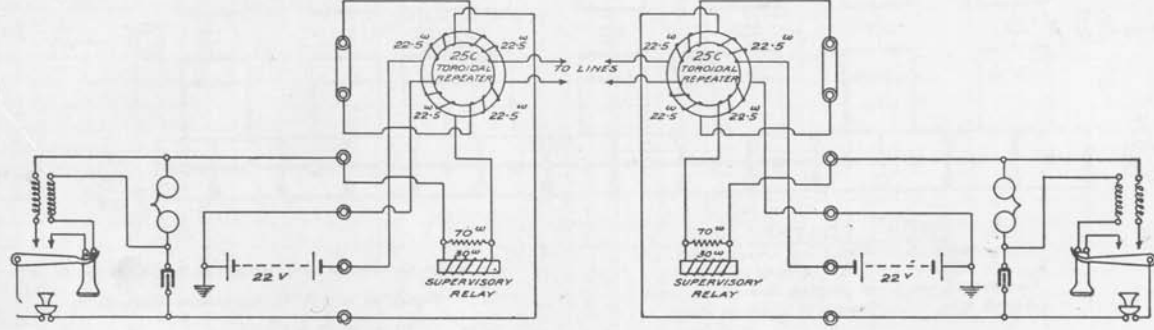

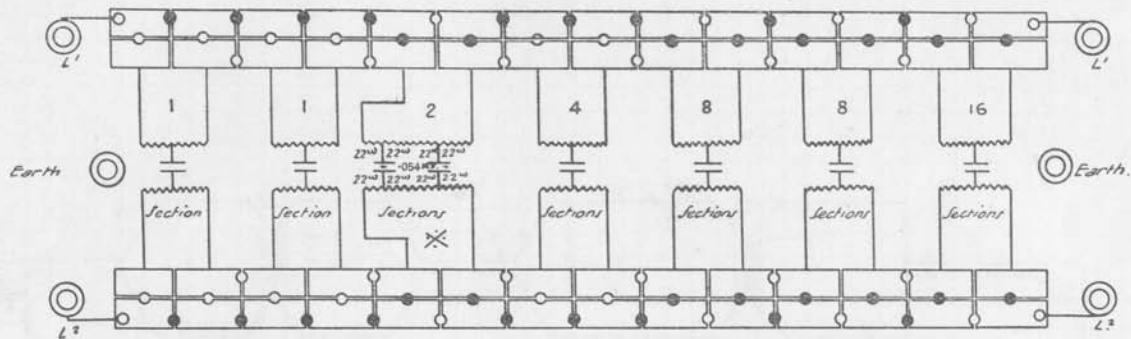

* Shows how 34 Sections are joined to plugs
 A Section marked 1 = 1 mile of cable
 " " 2 = 2 miles . . etc.

EXPLANATORY NOTE.
 4 Sections will contain 4 condensers and 16 coils of 22Ω
 The end portion on right (16 Sections) will contain 16 Condensers and 64 coils of 22Ω
 Total 40 Sections containing 40 condensers and 160 coils of 22Ω representing 40 miles of Standard Cable.

ARTIFICIAL LINE, for TRANSMISSION TESTS ON
C.B. TELEPHONES Prior to installation.

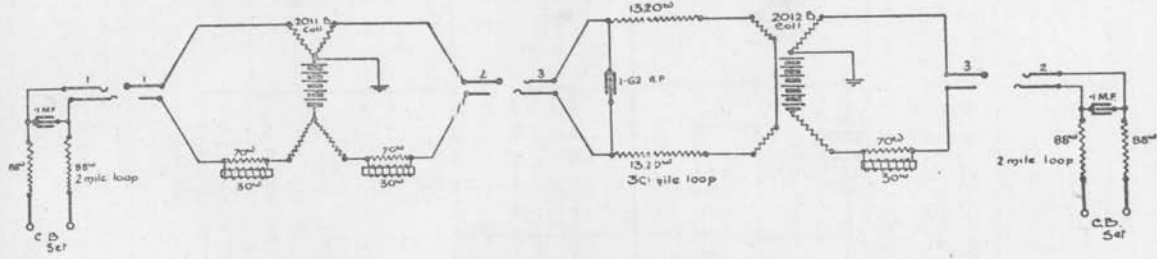
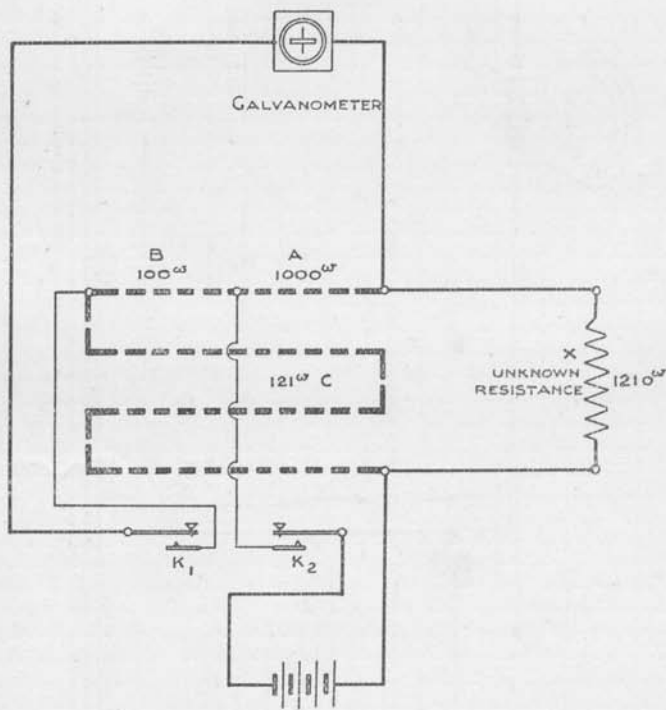

Diagram 108.

MEASUREMENT OF CONDUCTOR RESISTANCE.
 by means of WHEATSTONE BRIDGE (P.O.Box.)



Adjust C until no deflection is obtained on Galvanometer upon depression of K₁ (K₂ being closed) then $x = \frac{A \cdot C}{B}$ or where ratio arms A & B are equal $x = C$
 Example A = 1000 B = 100 C = 121, then $x = \frac{1000 \times 121}{100} = 1210 \Omega$

MEASUREMENT OF RESISTANCE BY MEANS
of MILLIAMPERE METER TESTING SET.

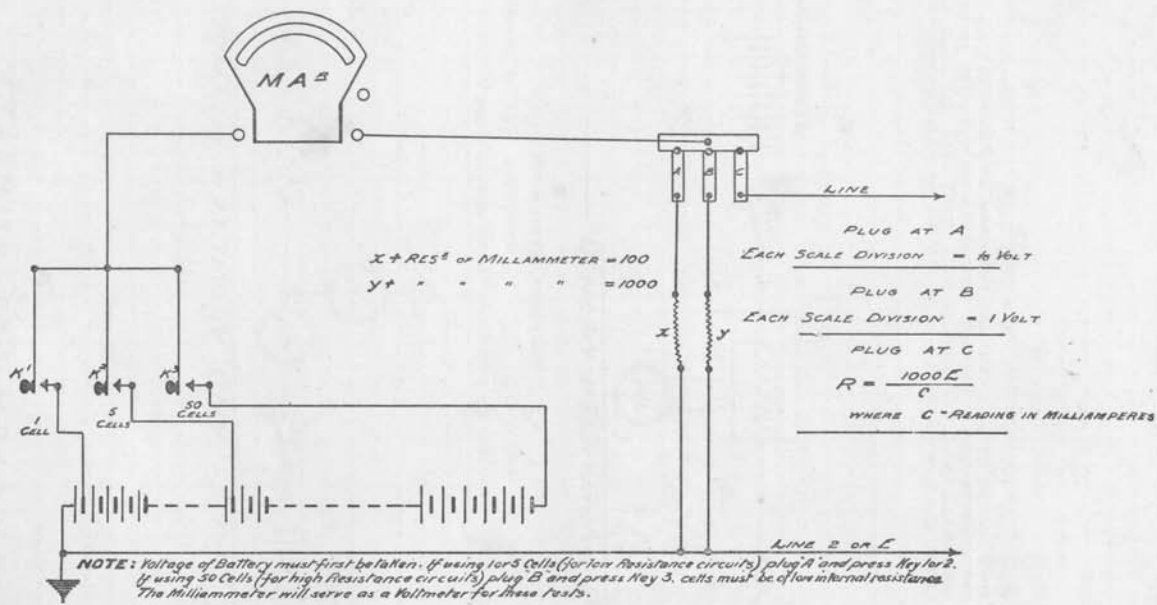

MEASUREMENT OF RESISTANCE BY MEANS OF VOLT-METER AND AMMETER.

— 1. VOLT-, AND AMMETER METHOD —

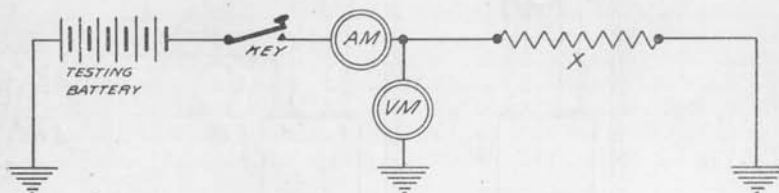

$$R = \frac{E}{C}$$

WHERE E = READING OF VOLTMETER VM IN VOLTS
 AND C = " " " AMMETER AM IN AMPERES
 " R = UNKNOWN RESISTANCE (X)

— 2. VOLTMETER METHOD —

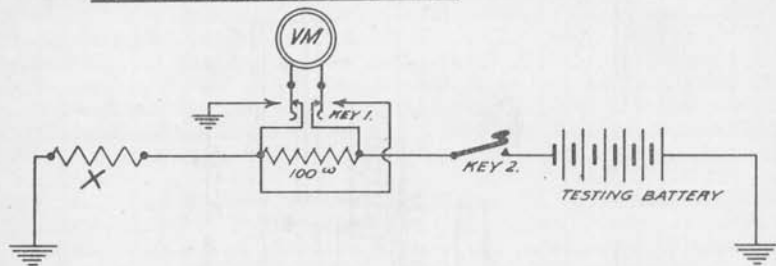

CLOSE KEY 2 AND OBSERVE DEFLECTION WITH KEY 1 NORMAL. THIS GIVES D.P. OVER 100 OHMS. CALL THIS D_1 . THEN PRESS KEY 1 PUTTING VOLTMETER IN PARALLEL WITH, AND GIVING D.P. OVER THE UNKNOWN RESISTANCE (X) CALL THIS D_2 , THEN $X = \frac{D_2 \times 100}{D_1}$

MEASUREMENT OF RESISTANCE BY MEANS OF BRIDGE MEGGER.

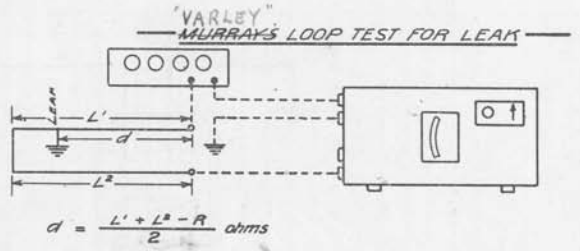
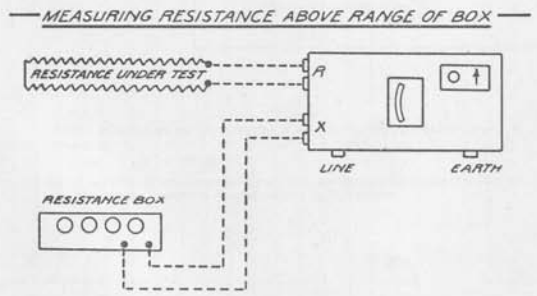
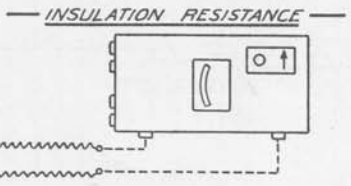
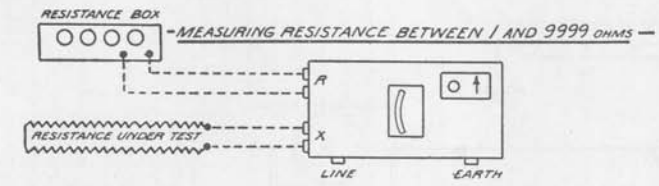
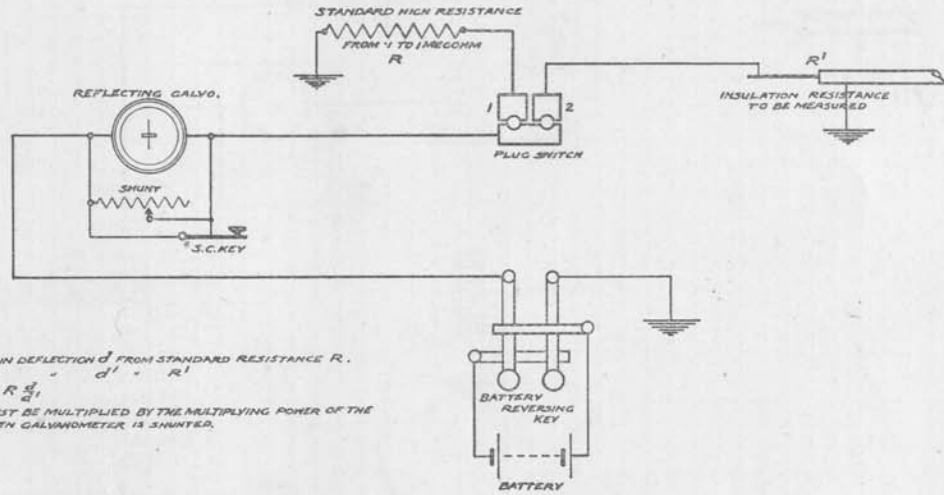

Diagram 112.

MEASUREMENT OF INSULATION RESISTANCE by means of Reflecting galvanometer.



PLUG 1. AND OBTAIN DEFLECTION d FROM STANDARD RESISTANCE R .
 THEN PLUG 2. " " " " " " " " " " " " " " $d' = R' / R$
 THEN $R' = R \frac{d}{d'}$
 NOTE - d & d' MUST BE MULTIPLIED BY THE MULTIPLYING POWER OF THE SHUNT WHEN GALVANOMETER IS SHUNTED.

Diagram 113.

MEASUREMENT OF CAPACITY BY THE DIRECT DEFLECTION METHOD.

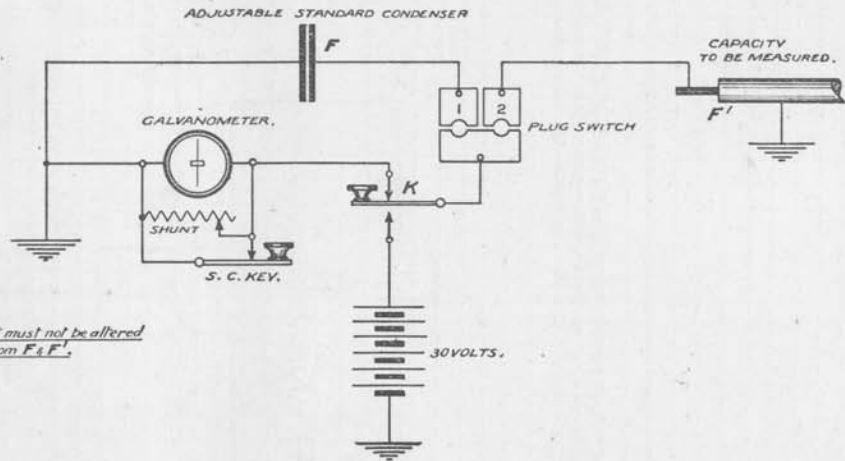

NOTE — During any one test the Shunt must not be altered whilst obtaining deflections from F & F'.

$$\text{Capacity of } F' = \frac{Fd'}{d}$$

where d is discharge deflection from F,
and d' F'.

Diagram 114.

MEASUREMENT OF CAPACITY by THOMSON'S METHOD.

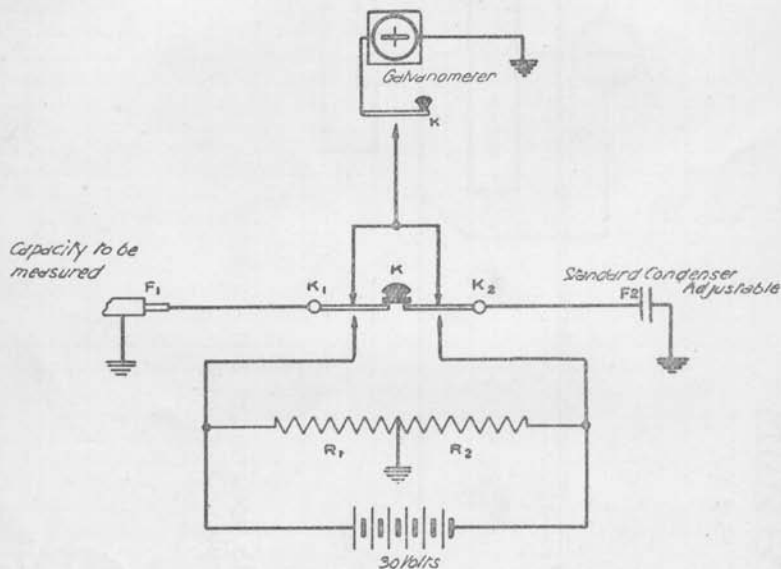

Adjust R_1 and R_2 as nearly as can be estimated in the proportion F_2 to F_1 . Depress K_1 and K_2 by knob K . Release K and allow charges to mingle then close K . Adjust R_1 and R_2 until no deflection on pressing K . Then Capacity of $F_1 = \frac{R_2 F_2}{R_1}$

MURPHY'S TEST

LOOP TEST.

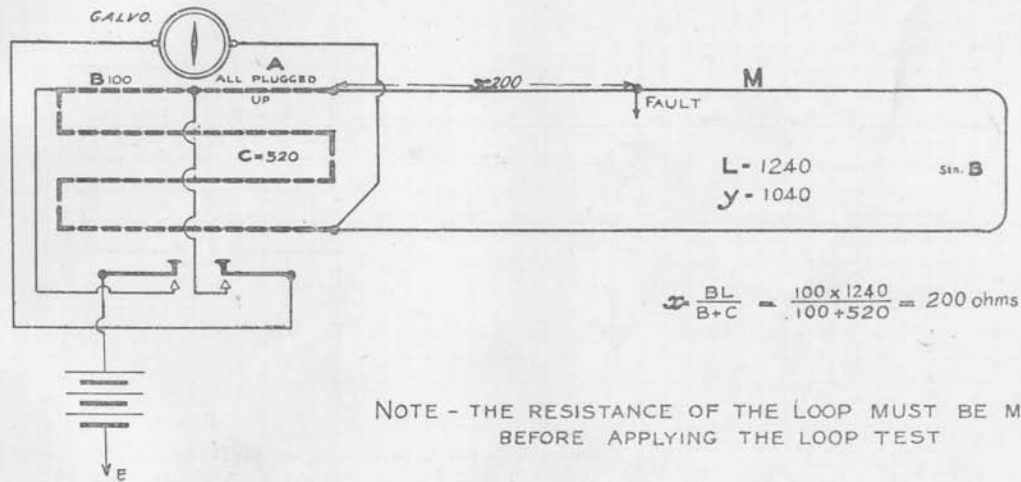

VARLEY'S TEST.

LOOP TEST.

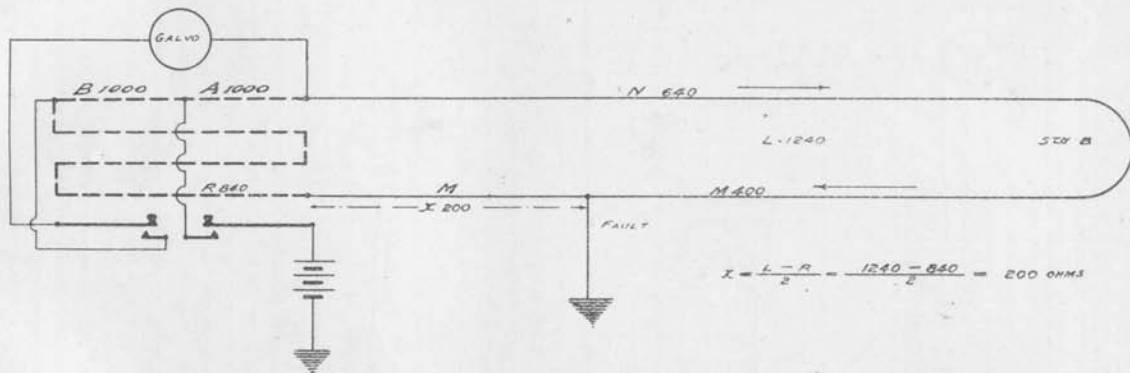

NOTE - THE RESISTANCE OF THE LOOP MUST BE MEASURED BEFORE
APPLYING THE LOOP TEST

LINEMANS DETECTOR B.P.O Type.

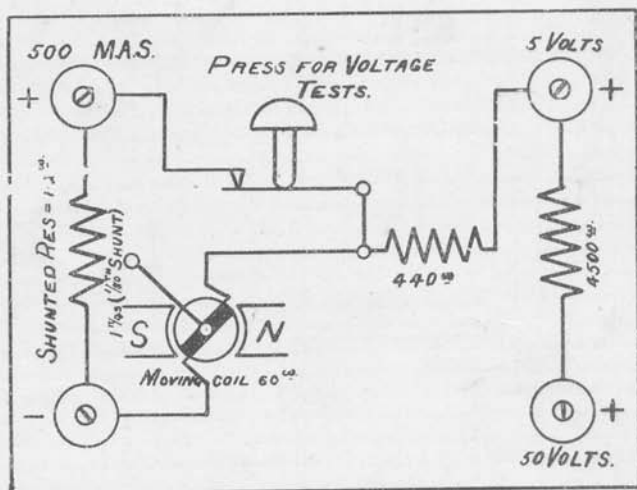
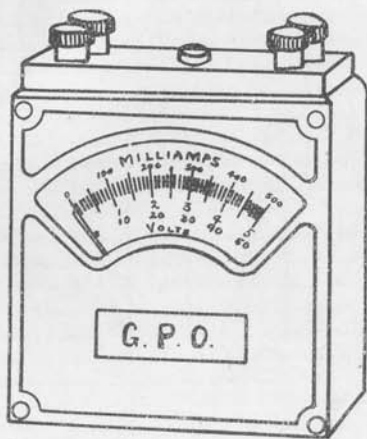
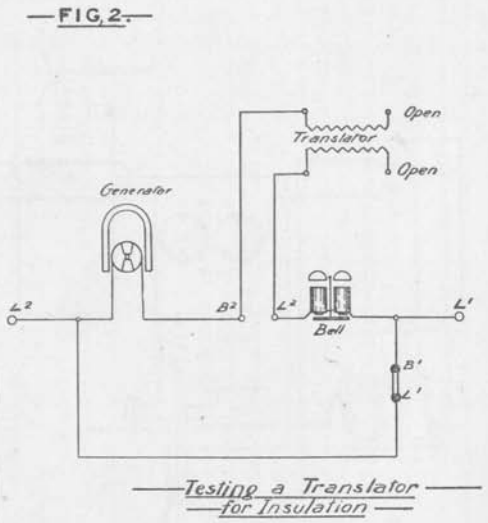
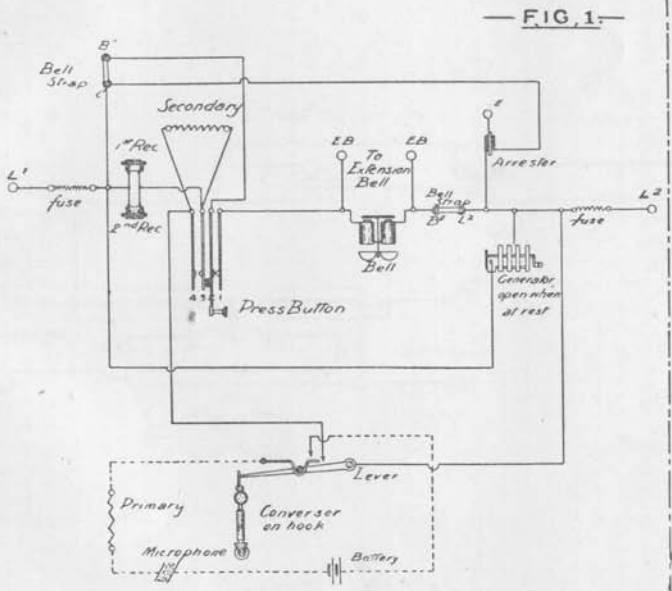

DIAGRAM OF CONNECTIONS.

INSULATION TEST OF TRANSLATOR BY MEANS OF COMMONWEALTH MAGNETO TELEPHONE.

E.C. 35



TESTING SET, MAGNETO EXCHANGE,
ERICSSON.

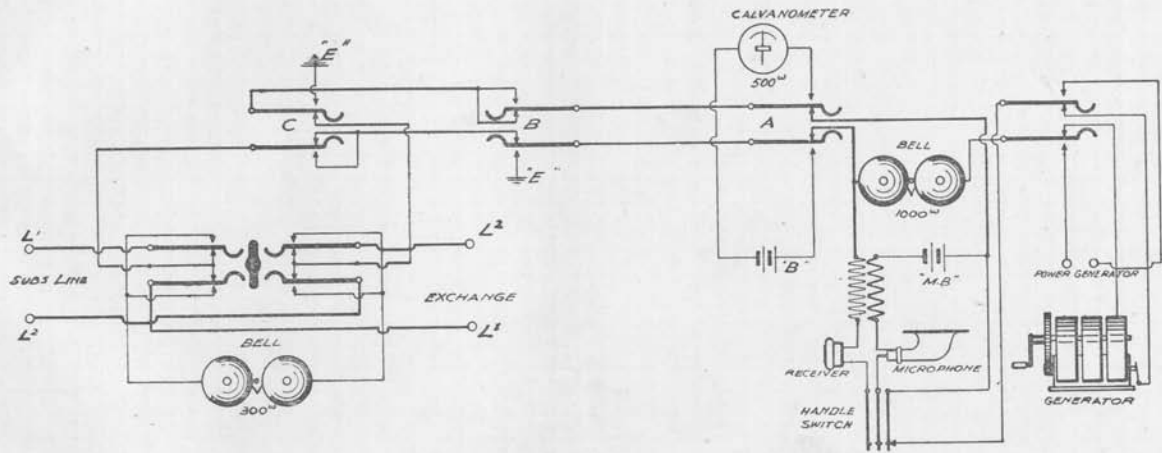

Diagram 120

APPENDIX.

APPENDIX

Voltage and Internal Resistance of Primary Cells ..	I.
Cells connected in Series and in Parallel-Series ..	II.
Condensers connected in Series and in Parallel ..	III.
Joint Resistance of Conductors connected in Parallel ..	IV.
Ohm's Law	V.
Measurement of Internal Resistance of Battery by Half Deflection Method	VI.
Resistance of various Conductors in General Use ..	VII.
Table of Fusing Currents for Wires	VIII.
Table of Co-efficients for converting Observed Copper Resistance	IX.
Numbers of Wires in Small Flexible Conductors ..	X.
British Standard Wire Gauge	XI.
Useful Numbers	XII.
Conversion Tables.. .. .	XIII.
Colour Code for Switchboard Cables.. .. .	XIV.
Table of Equivalent Lengths of Line and Limiting Distances for Commercial Speech	XV.
Curves showing Transmission Values of Various Aerial and Underground Conductors in Terms of Standard Cable	XVI.
Table of the Effective Resistance, Inductance, and Impedance of Standard Telephone Apparatus ..	XVII.

I.—Voltage and Internal Resistance of Various Types of Primary Cells in use in the Commonwealth.

Type of Cell.	Voltage.	Internal Resistance.
Leclanche, 3-pint	1.3 Volts ..	.8 ohm
„ 2-pint	1.3 „ ..	1.0 „
Dry Cell, 3" x 3" x 7 $\frac{1}{4}$ "	1.3 „ ..	0.15 „
Meidinger Line	1 Volt ..	3 to 6 ohms
„ Local (Large)	1 „ ..	2 „ 4 „
Gravity, Callaud (9 $\frac{1}{2}$ " x 5")	1 „ ..	1 $\frac{1}{2}$ „ 2 $\frac{1}{2}$ „
„ Star Zinc (8 $\frac{3}{4}$ " x 6 $\frac{3}{4}$ ")	1 „ ..	1 „ 2 „
Standard Cell, 3-pint	1 „ ..	2 ohms (maximum)
„ „ 2 pint	1 „ ..	2 „ „
„ „ 1 pint	1 „ ..	3 „ „

NOTE.—The above figures are approximate, and represent the Voltage and Internal Resistance of the respective types of Cells in good working order under average conditions.

Method of Testing Cells by means of Lineman's Detector and Subdivided 5000 ohm. Resistance Box.

1. Take the Voltage reading on the lower or red scale of the Detector. Call reading V.1.

2. Shunt the Battery by means of the Testing Coil with a resistance of 2 ohms per Cell. Note immediately the second reading V.2 (It is important that this reading be taken immediately.)

3. At the end of one minute's application of the Shunt disconnect it. Note immediately the third reading V.3. (This reading also must be taken immediately after disconnection.)

If V.2 be not less than half V.1 then the reading V.3 may be taken as the Effective Voltage of the Battery.

The internal resistance of the Battery may be then easily calculated. It will be equal to the product of the Shunt value (that is, 2 ohms) into the difference between V.1 and V.2, divided by V.2. *i.e.*—

$$R = \frac{S (V.1 - V.2)}{V.2}$$

Where S is the resistance used to Shunt the Battery.

II.—Cells Connected in Series and in Parallel—Series.

CELLS IN SERIES.



Total E.M.F. = Number of Cells \times E.M.F. of one Cell.

Total Internal Resistance = Number of Cells \times Internal Resistance of one Cell.

CELLS IN PARALLEL.

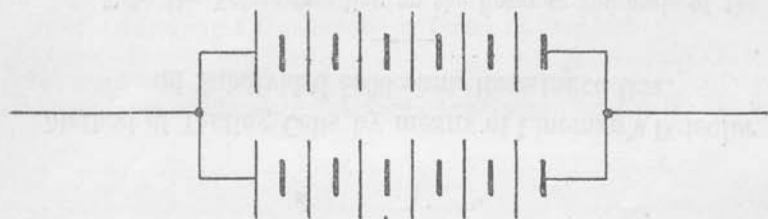

Total E.M.F. = Number of Cells in series (in one bank) \times E.M.F. of one Cell.

Total Internal Resistance = Number of Cells in series \times Internal Resistance of one Cell, divided by the number of banks of Cells.

NOTE.—When joining banks of Cells in parallel, care should be taken that the same number of similar Cells is connected in each bank.

III.—Condensers Connected in Series and in Parallel.

SERIES (OR CASCADE).

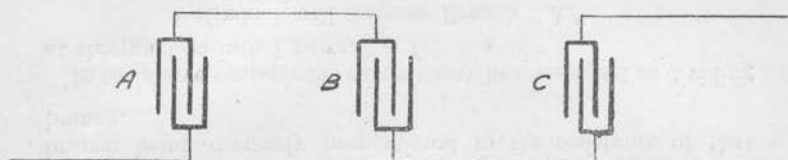

The total capacity obtained by joining Condensers in series is less than the capacity of any one of the Condensers so connected. Thus, three Condensers, A, B, and C, of 1, 2, and 2 microfarads capacity respectively give a total capacity of $\frac{1}{2}$ microfarad when connected in series. The method of calculating the effective capacity (F) of Condensers in series is as follows:—

$$F = \frac{1}{\frac{1}{A} + \frac{1}{B} + \frac{1}{C}} = \frac{1}{\frac{1}{1} + \frac{1}{2} + \frac{1}{2}} = \frac{1}{\frac{4}{2}} = \frac{2}{4} = \frac{1}{2} \text{ mfd.}$$

PARALLEL.

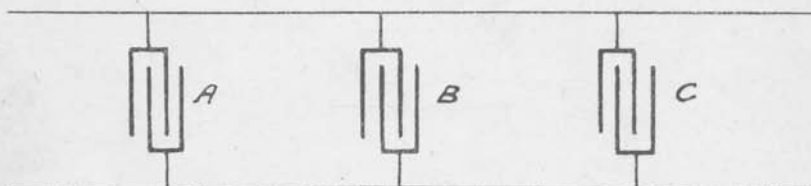

The total capacity obtained by joining Condensers in parallel is equal to the *sum* of the capacities of the Condensers so joined. Thus, three Condensers of 1, 2, and 2 microfarads capacity respectively give a total capacity of 5 microfarads when connected in parallel.

IV.—Joint Resistance of Conductors Connected in Parallel,

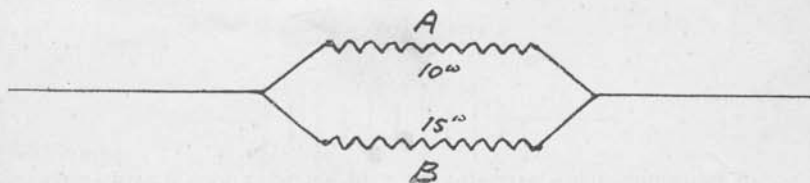

$$\text{Joint Resistance of A and B} = \frac{A \times B}{A + B} = \frac{10 \times 15}{25} = 6 \text{ ohms}$$

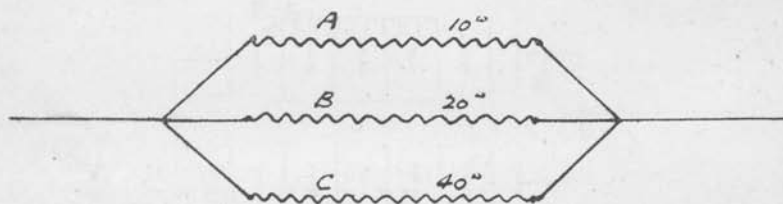

Joint Resistance of A, B, and C =

$$\frac{1}{\frac{1}{10} + \frac{1}{20} + \frac{1}{40}} = \frac{1}{\frac{4}{40} + \frac{2}{40} + \frac{1}{40}} = \frac{1}{\frac{7}{40}} = \frac{40}{7} = 5.7 \text{ ohms.}$$

A current flowing in the main circuit will divide at the junction of branches, A, B, and C, the current passing through any one branch being inversely proportional to the resistance of that branch.

In the above example the current may be considered as dividing at the junction into 7 parts,

4	of which will traverse	Branch	“	A.”
2	”	”	”	“
1	”	”	”	“
				C.”

V.—OHM'S LAW.

$$\text{Current (in amperes)} = \frac{\text{E.M.F. (in Volts)}}{\text{Resistance (in ohms)}} \quad C = \frac{E}{R}$$

$$\text{Resistance} \dots = \frac{\text{E.M.F.}}{\text{Current}} \dots \dots R = \frac{E}{C}$$

$$\text{E.M.F.} \dots = \text{Current} \times \text{Resistance} \quad E = CR$$

A Millivolt is the one-thousandth part of a Volt.

A Milliampere is the one-thousandth part of an Ampere.

$$\text{Current (in Milliampere)} = \frac{\text{Volts} \times 1000}{\text{ohms}}$$



VI.—Measurement of Internal Resistance of Battery by the Half Deflection Method.

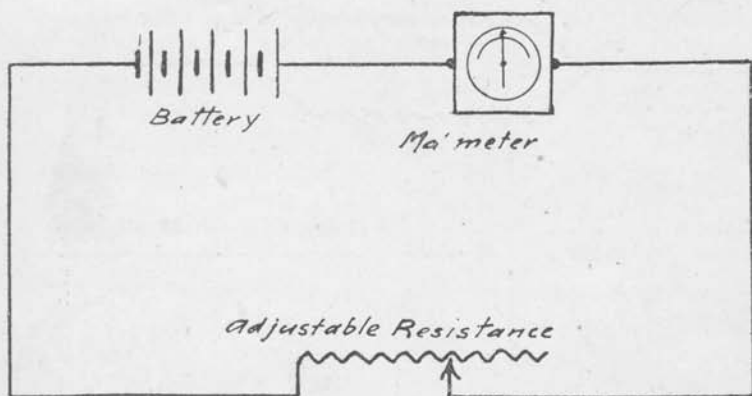

(1) Adjust Resistance to such a value (R) that a conveniently large deflection is obtained on the Milliamperemeter.

(2) Increase Resistance to R , so that the deflection on Milliamperemeter is exactly one-half of the first deflection. Then the Internal Resistance of Battery = $R - (2R + M)$, where M is Resistance of the Milliamperemeter. If the Milliamperemeter is of comparatively low resistance, as is usually the case, its effect may be neglected in the calculation, and the Resistance of Battery is then found by subtracting twice the value of the first Resistance from the value of the second Resistance.

Example.—A Battery of 30 Meidinger Cells produced a current of 120 Milliampères when R was made 100 ohms. To reduce the current to 60 Milliampères it was found necessary to make R 350 ohms. The Resistance of the Milliamperemeter used was less than 1 ohm.

The Internal Resistance of Battery therefore = $R - 2R = 350 - (2 \times 100) = 150$ ohms.

~~100 - 700~~

VII.—Resistance per mile (at 60° Fahrenheit) of Various Conductors in General Use.

Class of Conductor.	Resistance at 60° Fahrenheit.	
	Standard.	Maximum Allowable.
Copper, H.D.—		
600 lbs. per mile	1·4645 ohms per mile ..	1·4938 ohms per mile
400 " " "	2·1968 " " " ..	2·2408 " " "
300 " " "	2·9291 " " " ..	2·9877 " " "
200 " " "	4·3936 " " " ..	4·4815 " " "
150 " " "	5·8582 " " " ..	5·9754 " " "
100 " " "	8·7873 " " " ..	8·9630 " " "
Tinned No. 16 LSWG, twisted pair outside dis- tributing wire	13·87 ohms per conduc- tor per pair mile
Tinned No. 18 LSWG, twisted pair outside dis- tributing wire	24·74 ohms per conduc- tor per pair mile
Copper, Annealed		
Tinned—		
No. 18 LSWG	24·0885 ohms per mile
" 20 "	42·8240 " " "
" 22 "	70·7909 " " "
" 23 "	95·392 " " "
" 24 "	114·635 " " "
Bronze—		
100 lb. per mile	20·30 " " "
70 " " "	29·00 " " "
50 " " "	40·60 " " "
40 " " "	50·75 " " "
Galvanized Iron—		
600 lbs. per mile..	8·88 ohms per mile ..	} The product of the Weight in pounds per mile into the Resis- tance in ohms per mile must not exceed 5328.
500 " " " ..	10·66 " " " ..	
450 " " " ..	11·84 " " " ..	
400 " " " ..	13·32 " " " ..	
300 " " " ..	17·76 " " " ..	
200 " " " ..	26·64 " " " ..	
150 " " " ..	35·52 " " " ..	
100 " " " ..	53·28 " " " ..	
75 " " " ..	71·04 " " " ..	

The Ohm-mile Constant for wire of any material is obtained by multiplying the Resistance (in ohms) of a mile of wire of the material by its Weight in pounds.

The Ohm-mile Constant, divided by the Weight in pounds of a mile of wire of any size will give its Resistance, and divided by its Resistance will give its Weight in pounds.

The Ohm-mile Constant for H.D. High Conductivity Commercial Copper Wire is :—Standard, 878·8 ; Maximum allowable, 896·4. The Ohm-mile Constant (maximum allowable) for Iron Wire is 5328.

VIII.—The Table given below shows the Sizes of Various Wires of Different Materials which will Fuse at the Currents given in the First Column.

(SIR W. H. PREECE.)

Current in Amperes.	Tin Wire.		Lead Wire.		Copper Wire.		Iron Wire.	
	Diameter, Inches.	Approximate. S.W.G.	Diameter, Inches.	Approximate. S.W.G.	Diameter, Inches.	Approximate. S.W.G.	Diameter, Inches.	Approximate. S.W.G.
1	0·0072	36	0·0081	35	0·0021	47	0·0047	40
2	0·0113	31	0·0128	30	0·0034	43	0·0074	36
3	0·0149	28	0·0168	27	0·0044	41	0·0097	33
4	0·0181	26	0·0203	25	0·0053	39	0·0117	31
5	0·0210	25	0·0236	23	0·0062	38	0·0136	29
10	0·0334	21	0·0375	20	0·0098	33	0·0216	24
15	0·0437	19	0·0491	18	0·0129	30	0·0283	22
20	0·0529	17	0·0595	17	0·0156	28	0·0343	20·5
25	0·0614	16	0·0690	15	0·0181	26	0·0398	19
30	0·0694	15	0·0779	14	0·0205	25	0·0450	18·5

NOTE.—The above numbers can only be taken as approximate, as the actual current required to fuse any gauge will depend on the length of fuse and cooling effects of the fuse block in which it is placed.

IX.—Co-efficients for Converting Observed Copper Resistances.

(Resistance at 60° F. = Observed Resistance × Co-efficient.)

Temperature, Fahrenheit.	Co-efficient.	Temperature, Fahrenheit.	Co-efficient.	Temperature, Fahrenheit.	Co-efficient.
85	·94677	67	·98454	49	1·02523
84	·94901	66	·98672	48	1·02758
83	·95083	65	·98891	47	1·02995
82	·95288	64	·99111	46	1·03232
81	·95493	63	·99331	45	1·03470
80	·95698	62	·99554	44	1·03710
79	·95906	61	·99776	43	1·03950
78	·96113	60	1·00000	42	1·04192
77	·96321	59	1·00224	41	1·04434
76	·96531	58	1·00450	40	1·04678
75	·96742	57	1·00677	39	1·04922
74	·96953	56	1·00904	38	1·05168
73	·97164	55	1·01132	37	1·05415
72	·97377	54	1·01361	36	1·05662
71	·97590	53	1·01592	35	1·05912
70	·97805	52	1·01823	34	1·06162
69	·98021	51	1·02055	33	1·06414
68	·98237	50	1·02289	32	1·06666

The average temperature Co-efficient for Copper Conductors = ·00238 per degree Fahrenheit (·00428 per degree Centigrade).

X.—British Standard Sizes of Annealed High Conductivity Commercial Copper Conductors.

NUMBERS OF WIRES IN SMALL FLEXIBLE CONDUCTORS.

Equivalent Solid Wire S.W.G.	No. 40 S.W.G.	No. 38 S.W.G.	No. 36 S.W.G.	No. 33 S.W.G.	No. 30 S.W.G.
23	25	16	10
22	34	22	14
21	44	29	18	10	..
20	56	36	23	13	..
19	70	45	28	16	10
18	100	64	40	23	15
17	136	87	54	31	21
16	178	114	70	41	27
15	225	144	90	52	34
14	278	178	110	64	42

XI.—British Standard Wire Gauge.

S. W. G.	Diameter in Mils. 1 Mil. = 0·001 in.	Pure Copper Wire, 60° F.		
		Resistance in Ohms.		Weight in lbs. per Mile.
		Per Yard	Per Mile.	
4	232	·00057	1·00	860
5	212	·00068	1·20	718
6	192	·00083	1·46	589
7	176	·00099	1·74	495
8	160	·00119	2·10	409
9	144	·00148	2·60	331
10	128	·00187	3·29	262
11	116	·00228	4·00	215
12	104	·00283	4·98	173
13	92	·00362	6·37	135·3
14	80	·00478	8·42	102·3
15	72	·00590	10·39	82·9
16	64	·00748	13·16	65·5
17	56	·00976	17·18	50·1
18	48	·01328	23·38	36·8
19	40	·0191	33·67	25·6
20	36	·0236	41·6	20·72
21	32	·0300	52·6	16·37
22	28	·0390	68·7	12·53
23	24	·0532	93·5	9·21
24	22	·0638	111·3	7·73
25	20	·0765	134·7	6·39
26	18	·0945	166·3	5·18
27	16·4	·1140	200·4	4·30
28	14·8	·1400	246	3·50
29	13·6	·1655	291·3	2·96
30	12·4	·200	350·3	2·46
31	11·6	·227	400·4	2·15
32	10·8	·262	462	1·86
33	10	·306	538·8	1·60
34	9·2	·361	636·6	1·353
35	8·4	·434	763·6	1·128
36	7·6	·530	933	·923
37	6·8	·662	1165	·739
38	6	·850	1497	·575
39	5·2	1·132	1992	·432
40	4·8	1·328	2338	·368
41	4·4	1·581	2782	·309
42	4	1·913	3367	·256
43	3·6	2·362	4157	·2072
44	3·2	2·990	5262	·1637
45	2·8	3·905	6872	·1253
46	2·4	5·316	9355	·0921
47	2	7·654	13470	·0638
48	1·6	11·95	21040	·0409
49	1·2	21·26	37420	·0230
50	1	30·61	53880	·0160

One per cent. increased resistance as calculated from the diameter is allowed on all Tinned Copper Conductors between the diameters of 0·118 inch and 0·028 inch inclusive.

Hard drawing increases the resistance of Copper Conductors by approximately 2·05 per cent.

XII.—Useful Numbers.

$$\pi = \frac{\text{Circumference}}{\text{Diameter}} \text{ of Circle} = 3.1416 = \frac{22}{7} \text{ nearly.}$$

$$\text{Circumference (C) of Circle} = \text{Diameter} \times \pi = \text{Radius (r)} \times 2\pi.$$

$$\text{Diameter (D) of Circle} = \frac{\text{Circumference}}{\pi} = C \times \frac{1}{\pi} = C \times .3183.$$

$$\text{Area of Circle} = D^2 \times \frac{\pi}{4} = D^2 \times .7854 = r^2 \times \pi.$$

$$\text{Area of Circle in Circular Mils} = D^2 = 4r^2 \text{ (D and r in Mils).}$$

Weight in lbs. of Water = .036 per cubic inch ; 62.4 per cubic foot ; 10 per gallon.

Weight in lbs. of 1 cubic inch—Of Aluminium, = .096 ; Copper, = .318 ; Cast Iron, = .26 ; Wrought Iron, = .28 ; Steel, = .288 ; Lead, = .41 ; Mercury, = .49 ; Tin, = .26 ; Zinc, = .25 ; Brass, = .3 ; Bronze, = .316.

One horse-power = 33,000 foot lbs. per minute = 746 watts.

One nautical mile, or naut, = 6086 ft. (nearly).

One telegraph naut = 6087 feet.

A knot is a velocity of one nautical mile per hour.

XIII.—To Convert—

Mils to Millimetres, $\times \cdot 0254$.	Millimetres to Mils, $\times 39 \cdot 37$.
Inches to Centimetres, $\times 2 \cdot 54$.	Centimetres to Inches, $\times \cdot 3937$
Feet to Metres, $\times \cdot 3048$.	Metres to Feet, $\times 3 \cdot 281$
Square Inches to Square Cms., $\times 6 \cdot 452$.	Square Cms. to Square Inches, $\times \cdot 155$.
Cubic Inches to Cubic Cms., $\times 16 \cdot 387$.	Cubic Cms. to Cubic Inches, $\times \cdot 061$.
Ounces to Grammes, $\times 28 \cdot 35$.	Grammes to Ounces, $\times \cdot 0353$.
Pounds (7,000 grains) to Kilo- grammes, $\times \cdot 4536$.	Kilogrammes to Pounds, \times $2 \cdot 205$.
Ohms per Yard to Ohms per Metre, $\times 1 \cdot 0936$.	Ohms per Metre to Ohms per Yard, $\times \cdot 9144$.
Ohms per Mile to Ohms per Kilo- metre, $\times \cdot 6214$.	Ohms per Kilometre to Ohms per mile, $\times 1 \cdot 609$.
Degrees Fahrenheit to Centi- grade, deduct 32, $\times 5$, and $\div 9$.	Degrees Centigrade to Fahren- heit, $\times 9 \div 5$, and add 32.
Nauts to Statute Miles, $\times 1 \cdot 1527$.	Statute Miles to Nauts, $\times \cdot 8675$.
Nauts (Telegraph) to Statute Miles, $\times 1 \cdot 1528$.	Statute Miles to Nauts (Tele- graph). $\times \cdot 8674$.

XIV.—Colour Code for Switchboard Cables.

Column 1.	Column 2.	Column 3.	Column 4.	Column 5.
White ..	Blue.. ..	Red Blue ..	Red ..	Black Blue
„ ..	Orange ..	Red Orange ..	„ ..	Black Orange
„ ..	Green ..	Red Green ..	„ ..	Black Green
„ ..	Brown ..	Red Brown ..	„ ..	Black Brown
„ ..	Slate ..	Red Slate ..	„ ..	Black Slate
„ ..	Blue White ..	Red Blue White ..	„ ..	Black Blue White
„ ..	Blue Orange ..	Red Blue Orange ..	„ ..	Black Blue Orange
„ ..	Blue Green ..	Red Blue Green ..	„ ..	Black Blue Green
„ ..	Blue Brown ..	Red Blue Brown ..	„ ..	Black Blue Brown
„ ..	Blue Slate ..	Red Blue Slate ..	„ ..	Black Blue Slate
„ ..	Orange White	Red Orange White	„ ..	Black Orange White
„ ..	Orange Green	Red Orange Green	„ ..	Black Orange Green
„ ..	Orange Brown	Red Orange Brown	„ ..	Black Orange Brown
„ ..	Orange Slate ..	Red Orange Slate	„ ..	Black Orange Slate
„ ..	Green White ..	Red Green White	„ ..	Black Green White
„ ..	Green Brown	Red Green Brown..	„ ..	Black Green Brown
„ ..	Green Slate ..	Red Green Slate ..	„ ..	Black Green Slate
„ ..	Brown White	Red Brown White	„ ..	Black Brown White
„ ..	Brown Slate ..	Red Brown Slate ..	„ ..	Black Brown Slate
„ ..	Slate White ..	Red Slate White ..	„ ..	Black Slate White
<i>Spare Wires :</i>				
White ..	Black ..	Red White ..	Red ..	Black Red White

Columns 1 and 2 make 43 Wire Cable, 3 spare wires.

Columns 1, 2, and 3 make 64 Wire Cable, 44 spare wires

Columns 1, 2, 3, and 4 make 84 Wire Cable, 4 spare wires.

Columns 1, 2, 3, 4, and 5 make 105 Wire Cable, 5 spare wires.

XV.—Table of Equivalent Lengths of Line and Limiting Distances for Commercial Speech.

Type of Line.	Constants per Mile of Loop.			Equivalent Lengths in Miles calculated.	Limiting Distances for Commercial Speech.	
	R Ohms.	K M.F.'s.	L Henries.		Calculated.	Experiment.
Underground—				Miles.	Miles.	Miles.
10-lb. cable ..	175·64	·07	·001	0·61	26	26
20-lb. „ ..	86	·055	·001	1	43	43
40-lb. „ ..	42	·056	·001	1·47	63	63
70-lb. „ ..	25	·063	·001	1·83	79	
100-lb. „ ..	17	·058	·001	2·45	105	
150-lb. „ ..	11·7	·065	·001	2·95	127	127
200-lb. „ ..	8·75	·07	·001	3·5	151	
Submarine—						
160-lb. cable..	12·9	·12	·00165	2·3	99	88
Aerial lines—						
100-lb. copper	18	·00808	·0039	8·45	363	
150-lb. „	11·9	·00839	·00376	11·7	503	473
200-lb. „	9	·00862	·00366	14·7	632	626
300-lb. „	6	·00893	·00355	21	903	903
400-lb. „	4·5	·00919	·00344	26·1	1,122	1,075
600-lb. „	2·97	·00958	·00331	36·8	1,582	1,582
800-lb. „	2·25	·00987	·00322	45·8	1,969	

The above table is taken from the Presidential Address of Mr. J. Gavey to the Institution of Electrical Engineers on 9th November, 1905. Columns 5 and 6 have been calculated from the formulæ of Professor Pupin for attenuation in the case of the cable lines where leakage can be neglected, and from that of Professor Campbell in the case of aerial lines—the latter formula taking into account the insulation, at the rate of 1 megohm per mile.

The unit in this table is 1 mile of Standard Cable (20 lbs. per mile) having the constants per mile of loop shown above. Standard Cable is now defined, however, as cable having copper conductors weighing twenty (20) lbs. per mile (36 mils diameter) with a loop resistance of eighty-eight (88) ohms per mile, and a capacity wire to wire of 0·054 microfarad per mile. The inductance is 1 millihenry (0·001 Henry), and the insulation resistance two hundred (200) megohms per mile—all the constants being measured at sixty (60) degrees Fahrenheit.

The Table of Equivalents will be found of great value in the economical design of circuits to fulfil any required standards, the numbers given in column 5, or their reciprocals, being used as factors in connexion with any particular class of line.

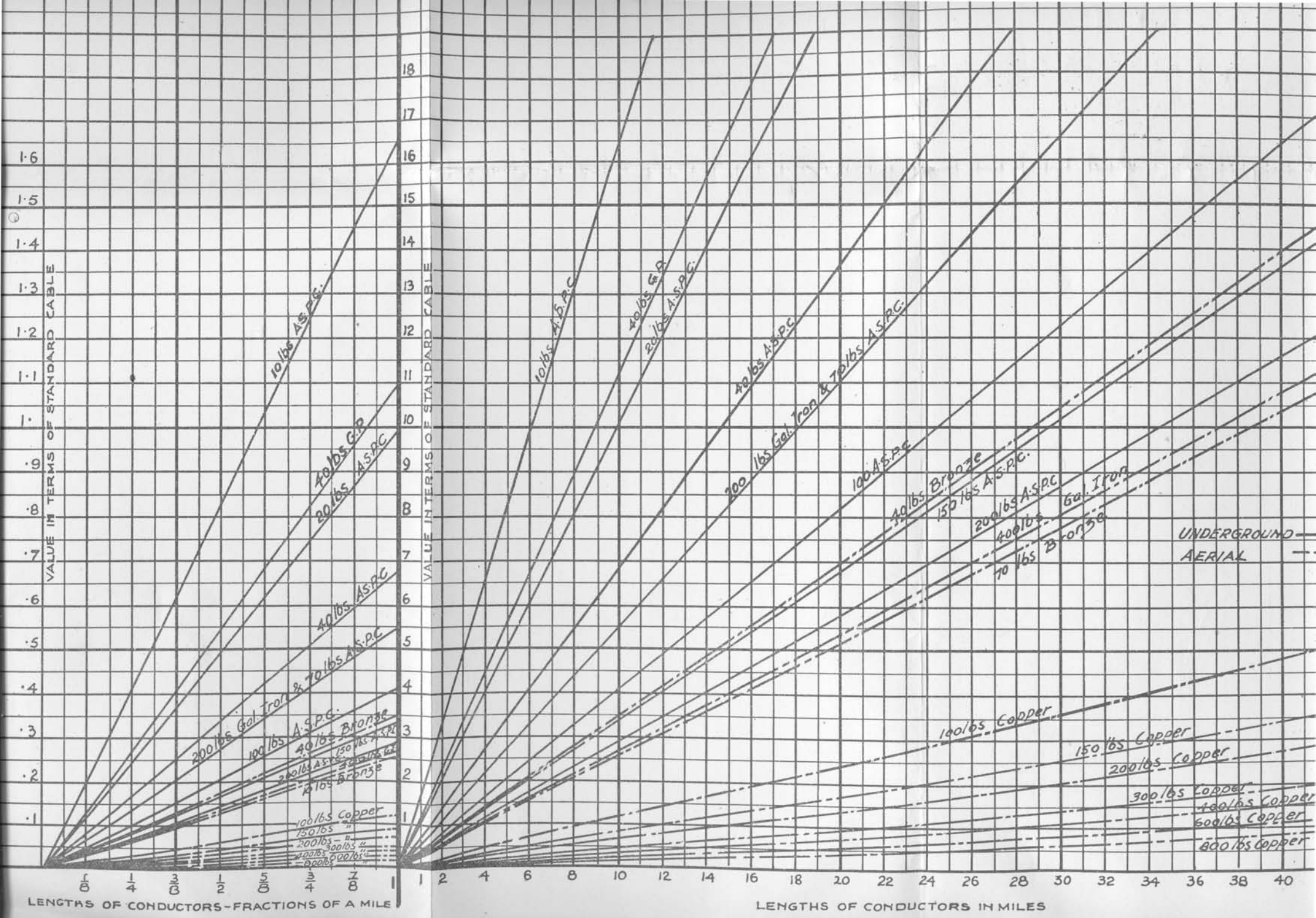

COMMONWEALTH OF AUSTRALIA
POSTMASTER GENERALS DEPARTMENT

CURVES SHOWING FOR VARIOUS AERIAL AND UNDERGROUND CONDUCTORS THE VALUES IN TERMS OF STANDARD CABLE
EXAMPLE :- 8 MILES OF 10 LBS A.S.P.C. = 13 MILES STANDARD CABLE.

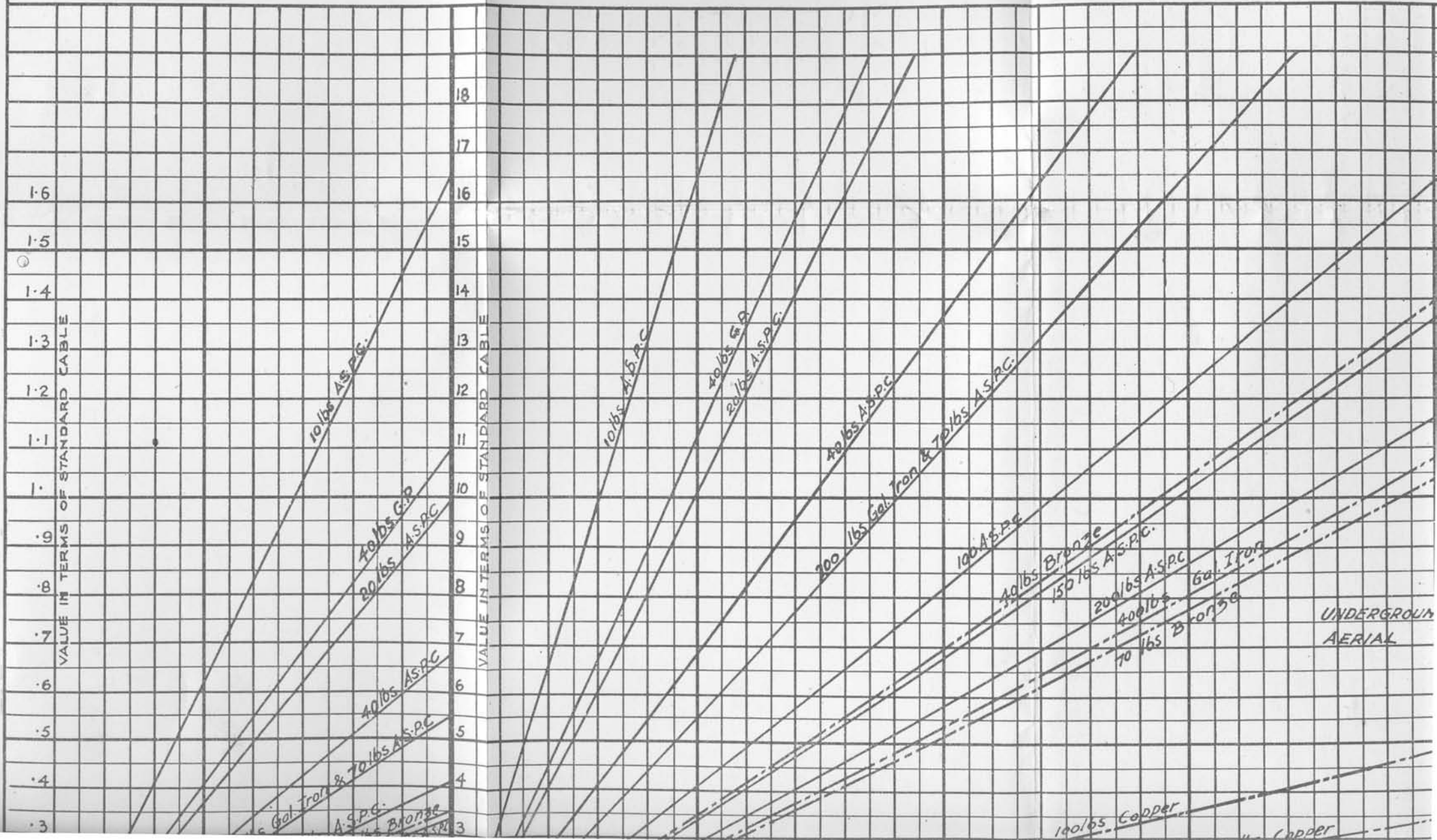

XVII.—Table of the Effective Resistance, Inductance, and Impedance of Standard Telephone Apparatus at 1,000 Alternations per Second.

Apparatus.	Effective Resistance. Ohms.	Inductance. Henries.	Impedance.		Loss in Milliwatts per 1 Volt.
			Ohms.	Angle.	
BELLS—					
1,000-ohm magneto ..	7,580	1.305	11,140	47° 9'	.061
INDICATORS—					
1,000-ohm tubular, ordinary ..	8,000	1.2	11,000	43° 24'	.066
600-ohm self-restoring ..	8,055	1.3	11,410	44° 55'	.062
100-ohm, plus 100-ohm eyeball signal, unoperated ..	3,900	0.512	4,035	14° 45'	.240
100-ohm, plus 100-ohm eyeball signal, operated ..	4,300	0.539	4,440	14° 3'	.219
RECEIVERS—					
Double-pole bell (60-ohm central battery) ..	134	0.018	176	40° 34'	4.33
RELAYS—					
500-ohm double make-and-break (W.E.) armature, not attracted ..	7,160	1.157	10,210	44° 54'	.069
500-ohm double make-and-break (W.E.) armature, attracted ..	7,960	1.238	11,150	44° 24'	.064
1,000-ohm double make-and-break (W.E.) armature, not attracted ..	9,910	1.543	13,845	44° 18'	.052
1,000-ohm double make-and-break (W.E.) armature, attracted ..	9,970	1.617	14,230	45° 30'	.049
RETARDATION COILS—					
100-ohm tubular ..	1,116	0.191	1,640	47° 6'	.414
200-ohm tubular ..	3,170	0.550	4,690	47° 30'	.144
400-ohm tubular ..	4,700	0.664	6,280	41° 30'	.119
600-ohm tubular ..	5,906	0.890	8,132	43° 20'	.089
1,000-ohm tubular, differential ..	19,100	0.538	19,400	10° 0'	.051
75-ohm, plus 75-ohm W.E. pattern, No. 2020A ..	1,827	1.367	8,770	77° 58'	.024
200-ohm, plus 200-ohm W.E. toroidal, No. 44B ..	3,600	13.5	85,000	87° 34'	.0005
No. 1 CENTRAL BATTERY TERMINATION (consisting of repeater, supervisory relay, local line and subscriber's instrument)—					
(a) No. 25 repeater, local line, 0-ohm ..	330	0.049	451	42° 57'	1.62
(b) No. 25 repeater, local line, 300-ohm (ohmic) ..	630	0.068	760	33° 54'	1.09
(c) No. 25 repeater, local line, 3-m. 20-lb. cable ..	680	0.049	746	23° 51'	1.22

NOTE.—To obtain loss in milliwatts at any voltage V , multiply figures in last column by V^2 .

The values of Effective Resistance, Inductance, and Impedance given above cannot be taken as accurate in the case of apparatus having the same ohmic resistance as similar apparatus in column 1, but differing from the latter in physical dimensions.

The preceding table is abstracted from an article on "The Impedance of Telephonic Apparatus," by B. S. Cohen, published in *The National Telephone Journal* for September, 1909, to which article and one on "Notes on an Instrument for Measuring Inductance," by G. M. B. Shepherd, given in the April, 1909, number of the same journal, the reader is referred for full particulars of the methods of measurement by means of alternating currents of high frequency (1,000 per second), so as to obtain a very close approximation to the effective resistance and impedance which the various classes of apparatus offer to the rapid alternations of actual speech-transmitting currents.

The measurements have been made at a frequency of 1,000 alternations, which, with a current strength of from 0.3 to 2 milliamperes, has been found to give an equivalent effect to actual speech waves.

It will be seen that the effective resistances and impedances given in the second and fourth columns differ very materially from the ordinary ohmic resistances to continuous current given in the first column, and this explains why a comparatively low ohmic resistance shunt, such as a 100-ohm retardation coil, has no appreciable effect on the speaking transmission when joined across even a long line, since the impedance of such a shunt to speech currents is raised more than sixteenfold.

Albert J. Mallett,
Government Printer, Melbourne.

ELECTRICAL ENGINEER'S BRANCH,
GENERAL POST OFFICE,
MELBOURNE.